

**New
Horizon
Shutters**

Because Beauty Should
Last Forever

Classic Custom Shutters by New Horizon



Quality Classic Shutters for America & Beyond

Collage Living

our 2007
idea home



Southern Living



**HGTV
Dream Home**



HINGES

Stainless Steel Screws are Provided with All Hinges

SUFFOLK STYLE "L" HINGE

Hand Forged Suffolk "L" Hinge. Sold as Pair (Left Hand

Item Code	Offset	Material
EHL R 0.00	0"	Carbon Steel
EHL R 0.50	1/2"	Carbon Steel
EHL R 1.75	1 3/4"	Carbon Steel
EHL R 2.25	2 1/4"	Carbon Steel
EHL SS 0.00	0"	Stainless Steel
EHL SS 0.50	1/2"	Stainless Steel
EHL SS 1.75	1 3/4"	Stainless Steel
EHL SS 2.25	2 1/4"	Stainless Steel

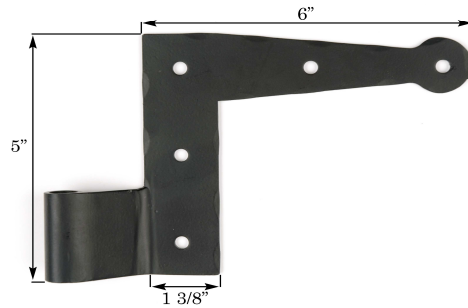

SUFFOLK STYLE CENTER HINGE

Hand Forged Suffolk Center Hinge. Sold as Pair.

Item Code	Offset	Material
EHH SS 0.50	1/2"	Stainless Steel



SUFFOLK STYLE STRAP HINGE

Hand Forged Suffolk Strap Hinge. Sold as Pair.

Item Code	Offset	Length	Material
EH S 3-12	1"	12"	Carbon Steel
EH S 4-18	1"	18"	Carbon Steel
EH SK SS 0.50	1/2"	10"	Stainless Steel



Surface Mount

Pictured at the right is a typical installation using the Suffolk Style "L" Hinge and the Rounded Pintle. The most common offsets used are the 1/2" Offset "L" Hinge with the 1 3/4" Offset Pintle.

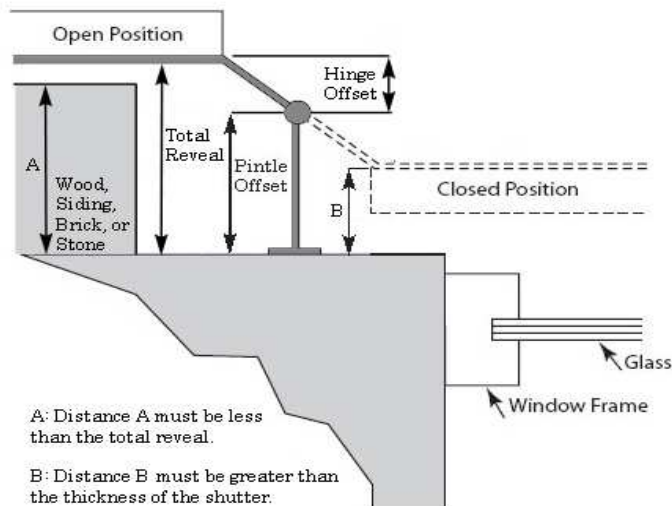

SEE NEXT PAGE FOR MATCHING PINTLES

PINTLES

Stainless Steel Screws are Provided with All Pintles

ROUNDED PINTLE

Hand Forged Pintle on 1 1/2" x 2 1/2" Plate with 1/2" Pin

Item Code	Offset	Material
EHP R 0.75	3/4"	Carbon Steel
EHP R 1.75	1 3/4"	Carbon Steel
EHP R 2.25	2 1/4"	Carbon Steel
EHP SS 0.75	3/4"	Stainless Steel
EHP SS 1.75	1 3/4"	Stainless Steel
EHP SS 2.25	2 1/4"	Stainless Steel
EHP SS 3.25	3 1/4"	Stainless Steel

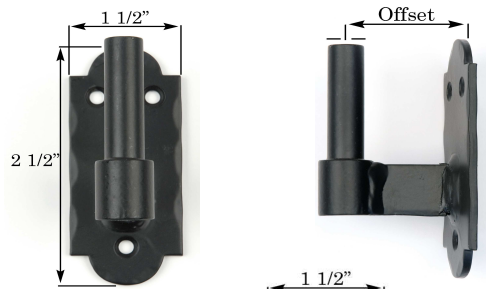

ROUNDED PINTLE SHIM

Shim for Rounded Pintle. Solid Plastic. Sold as Each.

Item Code	Thickness	Material
EHP SHIM	1/4"	Plastic

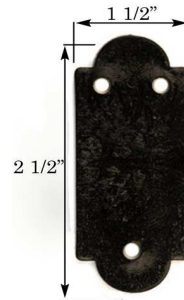

SQUARE PINTLE

Hand Forged Pintle 2" x 3 1/2" Plate with 1/2" Pin Diameter

Item Code	Offset	Material
SQP	1"	Carbon Steel

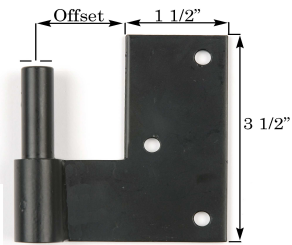
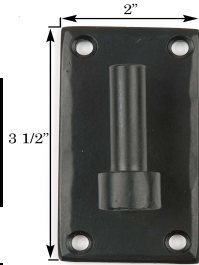

LEAF PINTLE

Hand Forged Pintle with 1/2" Pin Diameter Sold as Pair

Item Code	Offset	Material
LB 1	1 1/4"	Carbon Steel
LB 2	2 1/4"	Carbon Steel



NARROW PLATE PINTLE

Hand Forged Pintle on 3/4" Plate Width with 1/2" Pin

Item Code	Offset	Material
EH NP SS 1.75	3/4"	Stainless Steel
EH NP SS 1.75	1 3/4"	Stainless Steel
EH NP SS 1.75	2 1/4"	Stainless Steel
EH NP SS 1.75	3 1/4"	Stainless Steel



ADJUSTABLE LAG PINTLE

Hand Forged Pintle with 1/2" Pin Diameter. Sold as Pair.

Item Code	Lag Length	Material
E-PSC-CS-4	4"	Carbon Steel
E-PSC-CS-6	6"	Carbon Steel
E-PSC-SS-4	4"	Stainless Steel
E-PSC-SS-6	6"	Stainless Steel

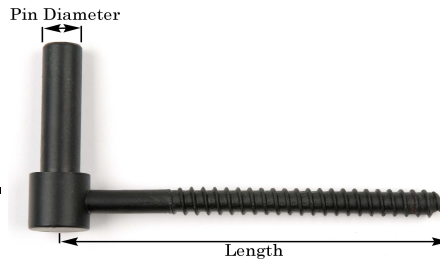

SHUTTER HINGE SETS

Stainless Steel Screws are Provided with All Shutter Hinge Sets

NEW YORK STYLE HINGE SET

Hand Forged Hinge Set 8 pieces: 2 Left Hand Hinges, 2 Right Hand

Item Code	Offset	Reveal	Material	Application
SH 1.25	1 1/4"	2 1/2"	Carbon Steel	For Wood
SH 2.25	2 1/4"	4 1/2"	Carbon Steel	For Brick
SH 5.25	5 1/4"	10 1/2"	Carbon Steel	For Stone

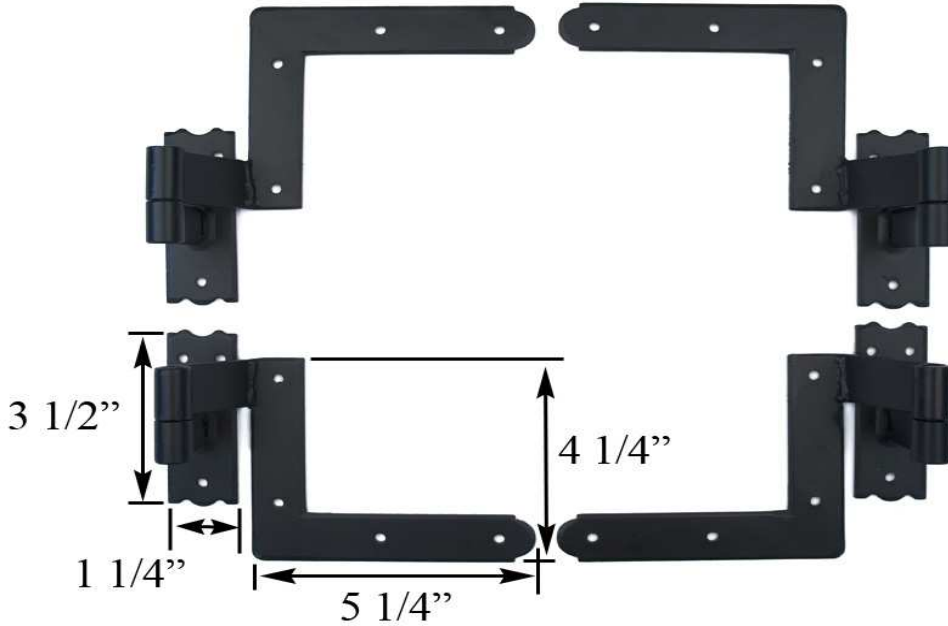

Please Note: 1 set contains enough hardware to

Recessed Mount

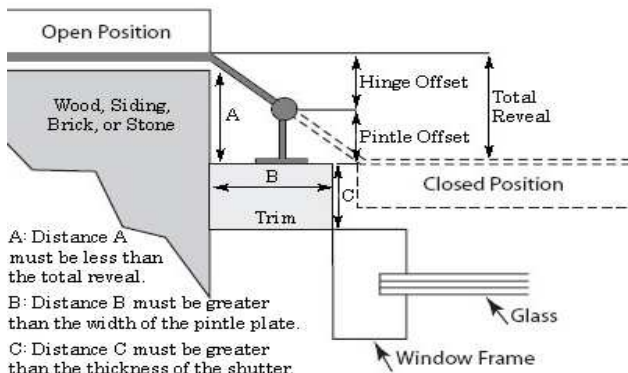

Flush Mount

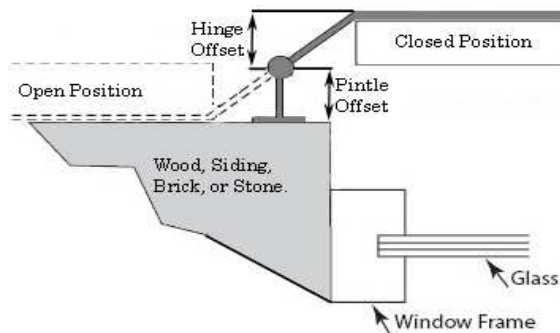

STAYS AND ACCESSORIES

Stainless Steel Lag Bolts or Screws are Provided with All Stays and Accessories

CLASSIC "S" STAY

Cast Aluminum. Sold as Pair (Left Hand and Right Hand).

Item Code	Length	Mount	Material
SD1	6"	Lag	Cast Aluminum
SD2	7"	Lag	Cast Aluminum
SD4	7"	Plate	Cast Aluminum

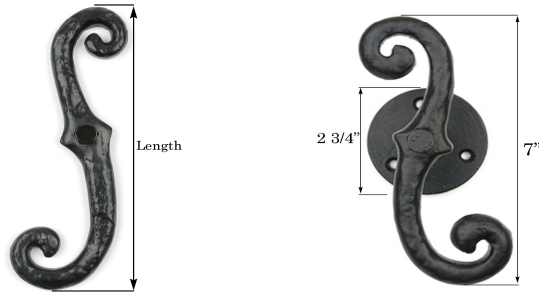

STAINLESS "S" STAY

Hand Forged Stainless Steel. Lag Mount. Sold as Pair

Item Code	Length	Mount	Material
SD3-SS	7"	Lag	Stainless Steel



FLAT RAT TAIL STAY

Cast Aluminum with Stainless Steel Lag Bolt. Sold as Pair

Item Code	Length	Mount	Material
RT1 F SS	8"	Lag	Cast Aluminum



PROTRUDING RAT TAIL STAY

Cast Aluminum with Stainless Steel Lag Bolt. Sold as Pair

Item Code	Length	Mount	Material
RT1 P SS	8"	Lag	Cast Aluminum

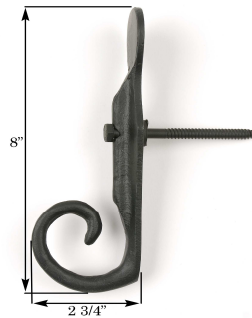

HIDDEN STAY

Stainless Steel. Sold as Pair.

Item Code	Material
E-SS 5/8 Catch	Stainless Steel

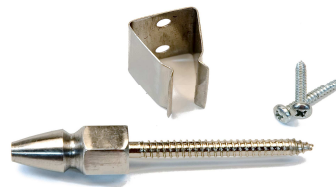

SLIDE BOLT

Heavy-Duty Stainless Steel. Sold as Each

Item Code	Length	Material
EHB SS	12"	Stainless Steel

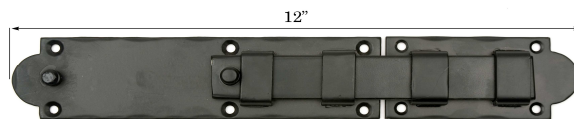

DECORATIVE HARDWARE

ALL OF THE DECORATIVE HARDWARE IS MADE OF CORROSION RESISTANT CAST ALUMINUM

HINGE FRONTS

SOLD AS PAIR

Picture	Item Code	Size
A	AL 3-12F	12" x 1 3/4"
A	AS 4-18F	18" x 2"
B	AL HF001	19" x 3 3/4"
C	AL HF005	21" x 5 1/4"
D	AL HF199-12	13" x 13"
E	AL HF37005	11" x 3"
E	AL HF37007	14" x 3"
E	AL HF37009	19" x 3"
E	AL HF37010	23" x 3"
E	AL HF37011	25" x 3"
E	AL HF37013	33" x 3 1/4"
E	AL HF37015	37" x 3 1/4"
F	AL FH5000	26" x 2"
G	AL HFFL18	18" x 3"
G	AL HFFL24	24" x 3"

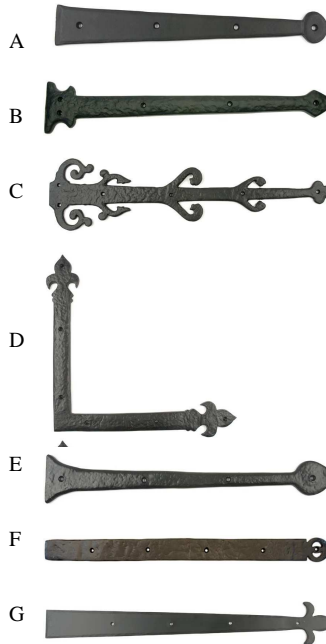

HANDLES

SOLD AS EACH

Picture	Item Code	Size	Projection
H	AL 209-9	9" x 2 1/2"	2 3/4"
I	AL FDL1	9" x 2"	1 1/2"
J	AL GH223	10 1/2" x 1 3/4"	2"
K	AL GH414	15 1/2" x 2 1/2"	3 1/4"
L	AL GL155-HLF	8"	2 1/2"
M	AL GL266-HLF	10"	2 1/2"
N	AL RH155	3" x 5"	2 1/4"
O	AL RH266	4"	2 1/4"
P	AL SP1	10" x 2"	1 1/2"
Q	AL SQH1	10 1/2" x 1 3/4"	2 3/4"
R	AL TP1	9"	2 3/4"
S	EH LH 001D	8" x 2 1/4"	2"
T	EH LH 002D	6" x 2 1/8"	2 3/4"
U	EH LH 003D	6 1/2" x 2"	2"

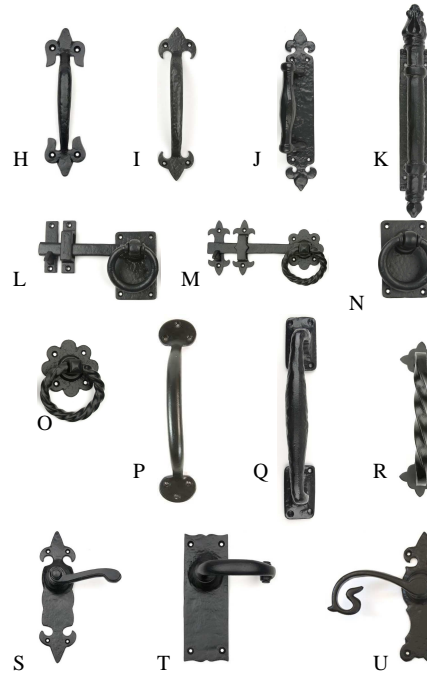

SOLD AS EACH

Picture	Item Code	Size
V	AL Grill	6 3/4" x 6 3/4"
W	AL CLV01	1 1/2"
X	AL 37999-.5	1/2"
X	AL 37999-.75	3/4"
X	AL 37999-1	1"



V



W

X