

Atlantic
Premium Shutters®

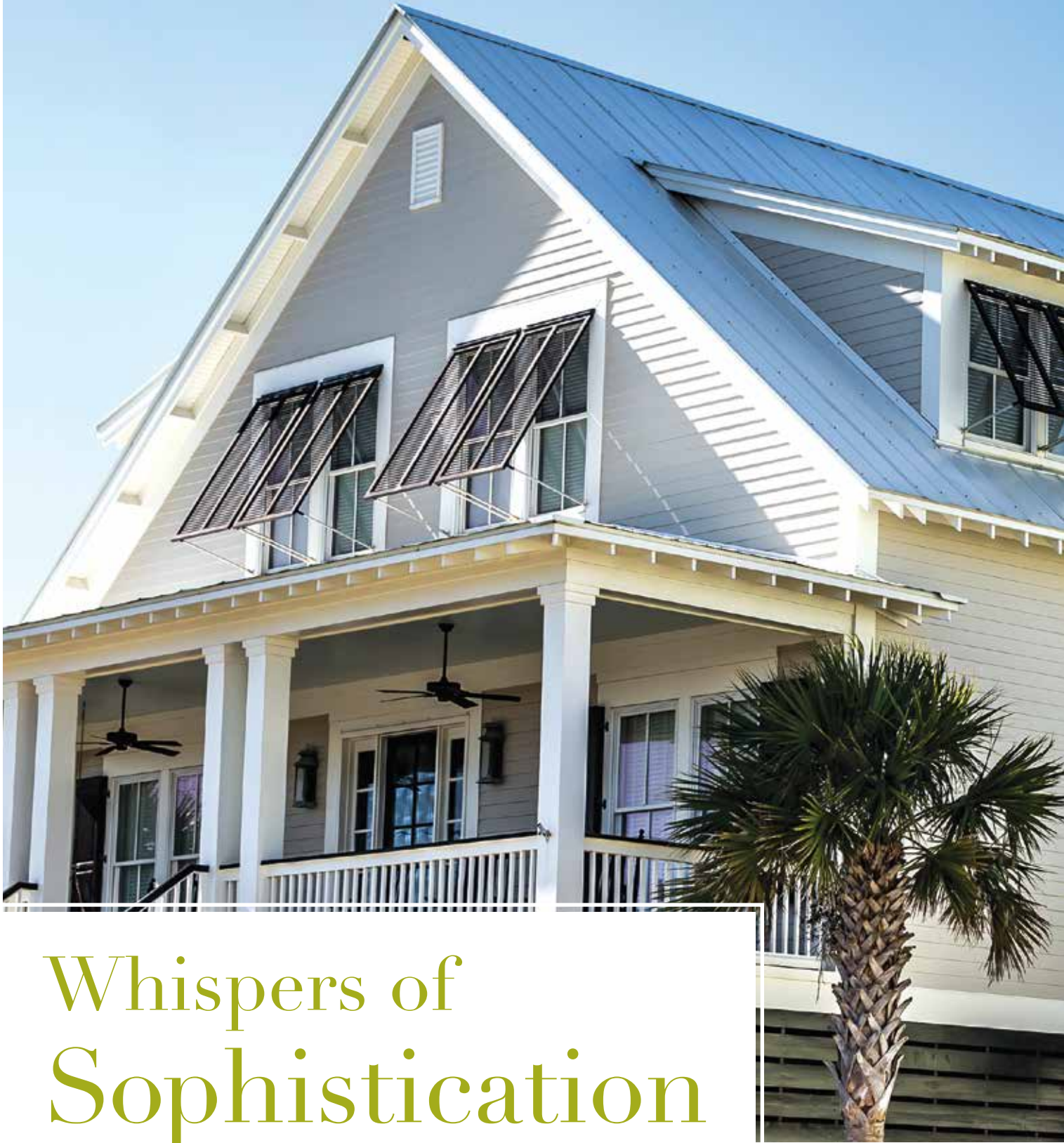

Because Every Home Tells a Story.



Whispers of Sophistication

Combining style, craftsmanship and durability, Atlantic Premium Shutters are as customizable as they are timeless. They offer a broad choice of styles that are architecturally and historically accurate - from classically traditional to uncommonly elegant to boldly adventurous.

Homes Reflect Personality.



In a cookie cutter world, Atlantic Premium Shutters can help your home, or your project, stand out. All while standing up to the inevitable wear and tear of time. With Atlantic Premium Shutters, you can make sure that personality is heard loud and clear.



Architectural Collection | Louvered Colonial | Board and Batten Red 650

The Architectural Collection

Repeating history, accurately and beautifully.

Uncompromisingly Durable

The shutters of the Architectural Collection beautifully reflect the time-honored look and functionality of traditional shutter design. Made with superior-quality materials, these shutters provide a lifetime of classic exterior charm without any maintenance required. The fully-functional shutters of the Architectural Collection are comprised of our Raised Panel, Louvered Colonial, Combination and Bahama shutter styles.

Hand-crafted Quality

The Architectural Collection uses modern materials with a centuries-old technique of mortise and tenon joinery to provide the strongest structural joint. And our shutters are hand-cut and hand-assembled to meet your exact specifications.

Durable Down to the Last Detail

Architectural Collection shutter frames feature unsurpassed durability due to the strength of the marine-grade fiberglass used in our proprietary stile and louver designs.

We use our own proprietary, exterior grade composite wood to manufacture solid, sturdy shutter panels. The shutter rails are crafted from single-sheet, structural-grade PVC delivering strength and stability, and allowing for custom rail sizing in louver style only. The specialized tooling of each of our selected materials enables the creation of fine, historically-correct detail.

Finishing Touches

Our advanced finishing process gives you enduring, vibrant colors that last a lifetime and our partnership with the world leader in finishes allows us to match almost any color. Meaning you can find the color you seek. And be sure you won't have to go through the agony of locating it ever again.

The **Architectural** Collection



Raised Panel

Raised Panel shutters offer a clean, handsome and elegant look for a variety of historic or modern home styles. The artistic depth and curves on the panels dramatically catch sunlight and impart alluring shadows. Popular two-panel and three-panel designs bring deep texture and solid, artistic appeal. A wealth of options is available for added sophistication, limited only by your imagination.



Standard



Single Panel



Extra Panel



Flat Panel



Custom Rail Location



Raised Panel & Louvered Colonial | Forest Green 633



Arch or Radius Top



V-Groove Flat Panel



Single Panel with
Vertical Cut Profile



Rabbeted Edge
with Beading



Louvered Colonial | Black 632

Louvered Colonial

True to centuries-old design, our Louvered Colonial shutters provide timeless elegance with the crisp lines of genuine open louvers. Just as louvered shutters performed the duties of keeping inclement weather out, protecting the home and allowing ambient light, our shutters today provide the same functionality with integrity that will stand throughout your lifetime.



Standard



Additional Rail



Vertical Mullion



Faux Tilt Rod



Louvered Colonial & Bahama | Tempest Blue 666



Custom Top or
Bottom Rail
Sizes



Solid Arch Top



Horns



Rabbeted Edge



Combination | Plum Creek 643

Combination

Combination shutters provide the creative outlet for homeowners and architects with a passion for the utmost in unique style. These shutters enable the full creativity of combining design elements of Raised Panel and Louvered Colonial shutters. Allowing a wide spectrum of personalized details, our Combination shutters can exceptionally enhance historical themes or create a signature look that's exclusively your own.



Standard



Extra Panel



Additional Rail



Vertical Mullion



Combination | Roycraft Copper Red 668



Faux Tilt Rod



Custom Top or
Bottom Rail Sizes



Solid Panel
Arch Top



Rabbeted Edge



Bahama

Atlantic's Bahama shutters bring refreshingly clean, versatile design. Inspired by the elegant functionality of shutters found throughout the Caribbean, Bahama shutters block out intense UV rays that can damage interiors, while allowing soft ambient light and refreshing breezes to pass through. Their airy, relaxed design offers a sophisticated privacy solution. Bahama shutters can be paired with various shutter styles to deliver a dramatic look. These shutters are a longtime favorite in coastal and tropical locales.

The **Architectural** Collection



Standard



Additional Rail



Additional Vertical Mullion

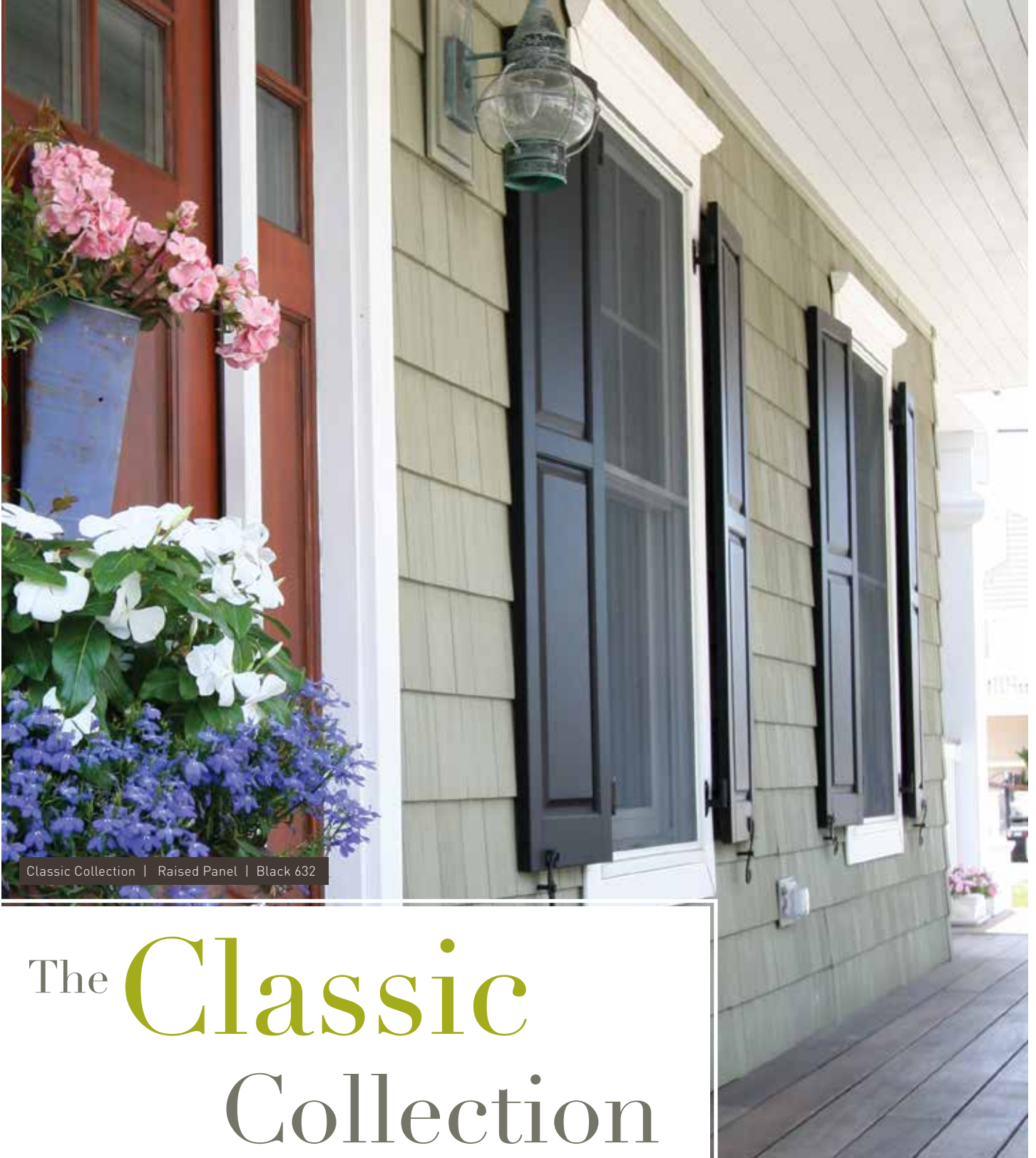

Classic Collection | Raised Panel | Black 632

The **Classic** Collection

Dimension that truly helps you stand out.

Skillfully Handcrafted

Whether operable or fixed to the home, Classic Collection shutters give any home eye-catching dimensions that truly let it stand out. Skillfully handcrafted, these shutters are available in the popular Board and Batten, Raised Panel and Faux Louver designs.

Uncompromising Craftsmanship

Classic Collection shutters are hand-crafted from our proprietary, exterior grade composite wood, including panels, stiles, rails and closed louvers. Components are machine and hand sanded, then hand assembled using tongue and groove joinery techniques that have been employed by skilled craftsmen for ages.

Enduring Beauty

An exclusive finishing process ensures the color you select holds its richness. It begins with two coats of durable, marine-grade primer, followed by specially-formulated industrial-grade 2-part urethane finish paint. Atlantic's unique oven-curing process hardens the finish paint into a protective shell with deep, vibrant color, permanently bonding the shutter material for extreme durability.



Raised Panel

Classic Collection Raised Panel shutters are an ideal accent for giving a home intimate character and attractive warmth. Their traditional design offers eye-catching dimension for a complete range of designs and exterior materials. Classic Collection Raised Panel shutters are offered with numerous options. An extra panel creates unmistakably rich texture; a single panel provides stately, crisp lines; popular arch or radius tops perfectly complement shaped windows for scenic custom looks.



Standard



Single Panel



Extra Panel



Flat Panel



Raised Panel | Pine 644



Custom Rail Location



Arch or Radius Top



V-Groove Flat Panel

The **Classic** Collection



Faux Louver | Deep Sea Blue 637

Faux Louver

Atlantic's Faux Louver shutters use a unique patented process that delivers a beautiful louvered appearance. These shutters add a classic, traditional look with rhythmic, clean lines. Enhancing a variety of home styles, Faux Louver shutters offer the popular option of an additional rail, accentuating both horizontal and vertical appeal. Rails also accommodate optional sliding-bolt hardware for a more handsome operable-shutter application. Arch and radius top shutters are also available to match this popular window design.



Faux Louver | Custom Color

The **Classic** Collection

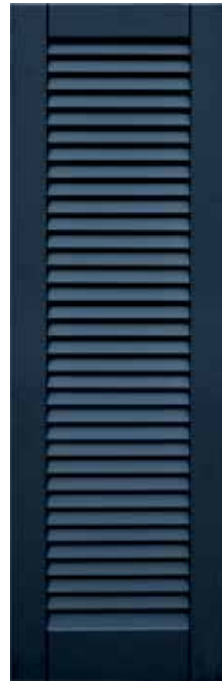

Standard



Additional Rail



Archtrop



Board and Batten | Custom Color

Board and Batten

With bold dimension and solid, colorful character, Board and Batten shutters distinguish homes with Old-World charm and a flourish of rustic style. These shutters offer a classic aesthetic for a variety of homes. Board and Batten shutters are a favorite choice for picturesque forest and lake homes. Popular options include z-bars, extra battens and arch or radius tops. To ensure historical accuracy, vertical grooves are approximately every 4 inches.



Standard



Z-Bar



Extra Batten



Board and Batten | Walnut 641



No Battens



Arch or Radius Top

The Pro Series

Atlantic's ProSeries Shutters are hand-assembled from exterior-grade composite wood components that will not rot, crack or split. ProSeries Shutters come ready to be painted with any high-quality exterior paint of your choice.



Louver



Raised Panel

Stand out from the crowd

Design details complete the front and back of each shutter, with four handsome styles available: Louver, Raised Panel, Flat Panel and Board and Batten. Corners and joints are true and square with tongue and groove construction that provides superior strength.

Each ProSeries shutter is machine sanded and finished with a single coat of marine-grade primer, reducing your time in applying a finish coat of paint.

The choice for versatility, custom color and outstanding charm.



Flat Panel



Board and Batten

Versatile

ProSeries shutters can be specified to correct window scale or sized as desired. Widths are available from 12" to 24" in half-inch increments; heights from 30" to 84" in inch increments. Quarter Round Arch Tops are also available. ProSeries shutters may be installed in fixed or operable applications and are backed by a 3-year structural warranty.

Unique Cut-outs

Anything but cookie-cutter.



Nothing provides warmth like a personal touch. With our standard and custom cut-out capabilities, you can enhance your home with inviting charm and a singular, beautiful look.

From stars to crescent moons and palm trees, cut-outs add eye-catching dimension and uncommon style, while at the same time letting your individuality shine through.

Standard cut-outs

Palm, Moon, Pineapple, Anchor, Star, Heart, Tree, Diamond and Sailboat.



Unique Cut-outs

Classic Collection | Raised Panel | Anchor Cut-out | Harbor 645

Authentic Hardware



A detail no one will miss.

Our architecturally-correct and historically accurate hardware is a small detail that speaks volumes to the attentive style of your home. An ornament in themselves, they evoke the craftsmanship of a blacksmith forging clean, elegantly simple architectural elements.

For fixed mounting applications, a clean finish is possible by using our clear polycarbonate L-brackets. Bahama shutters use aluminum hardware that is available in a mill or anodized aluminum black finish.



Providing full utility, our durable hardware is forged from 304 series stainless steel with a matte black, powder coat finish. From depth-enhancing Slide Bolts to smoothly attractive "S" Holdbacks and Rat-tail Holdbacks, hardware pieces amplify style with endearing simplicity.

When shutters are in the open position, our traditional hardware adds beautiful dimension by setting the shutters off from the home, allowing a hint of exterior cladding to be visible between each shutter leaf and the structure for a noticeable fine touch.

Impact-Resistant Storm Shutters



Bahama Storm System
Can be locked from the inside and outside



"U" Locking Storm Bar System
Locks from the inside



Horizontal Storm Bar System
Locks from the outside

You can count on Atlantic's Impact-Resistant storm shutters to protect your coastal home. Atlantic's Inside Locking U-Shaped Storm Bar System features two U-shaped storm bars that lock from the interior when the shutters are closed. Each shutter leaf has a 1/8" thick clear polycarbonate panel fastened to its back, helping protect the shutter leaf, the window and your home's interior. The system meets the Large Missile Impact Test requirement as specified in the IRC and IBC 2006.

The system is available for Architectural Collection shutters in Louver and Raised Panel styles (does not apply to arch and radius top shutters, cut-outs, or combination styles). When your shutters are in the open position, the polycarbonate backing remains hidden from view, so your home evokes a scenic, seamless charm.



High Level of Home Protection

The Bahama Storm System offers the same high level of home protection, but with our unique Bahama style Architectural Collection Shutters that offer sleek, versatile aesthetics. A 1/8" thick clear polycarbonate panel is permanently attached to the back of the shutter. A camelback locking system specifically designed for the Bahama style is installed along the sides of the shutter. With the Bahama Storm System, you gain privacy, ambient light, fresh air, and home-protecting toughness independently tested to a design pressure of 60 PSF.

The Bahama Storm System meets the Large Missile Impact Test requirement as specified in the IRC and IBC 2006. This system also meets the State of Florida Building Code 2007.

Color

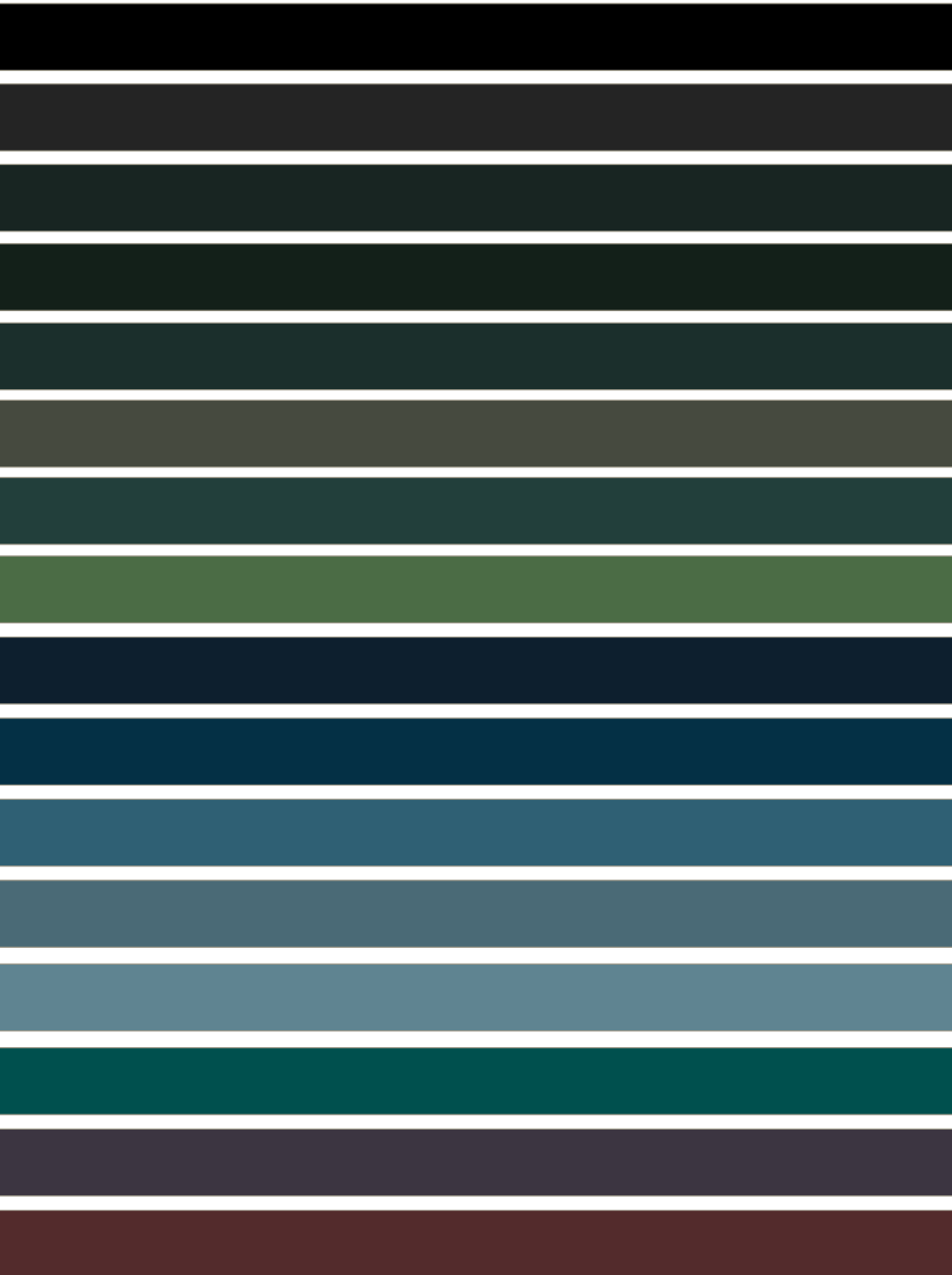

Black 632

Charleston Green 653

Rookwood Shutter Green 654

Roycraft Bottle Green 655

Evergreen 638

Rookwood Dark Green 656

Forest Green 633

Pine 644

Midnight Sky 639

Deep Sea Blue 637

Tempest Blue 666

Hamilton Blue 667

Harbor 645

Cascade 647

Plum Creek 643

Bordeaux 640



Visually Striking Colors to Set you Apart.

Roycraft Copper Red 668



Board and Batten Red 650



Federal Brown 635



Polished Mahogany 657



Rookwood Medium Brown 658



Walnut 641



Craftsman Brown 659



White 631



Roycraft Pewter 663



Pewter 646



Roycraft Mist Gray 664



Chelsea Gray 662



Hammered Silver 661



Sand 642



Weathered Shingle 660



Actual colors may vary from printed representation.





GENERAL NOTES

To deflect rain away from the structure, louvered shutters should be installed so the louvers face AWAY from the structure when shutters are closed.

Shutter swing is 3" per shutter from the edge of the open shutter to the edge of the window opening when the shutter is closed; be sure to check for proper clearance (i.e. lamps, fixtures) when the shutter is in the open position.

Hinges are usually applied to the back of the shutter. They are only visible in their entirety when the shutter is in the closed position.

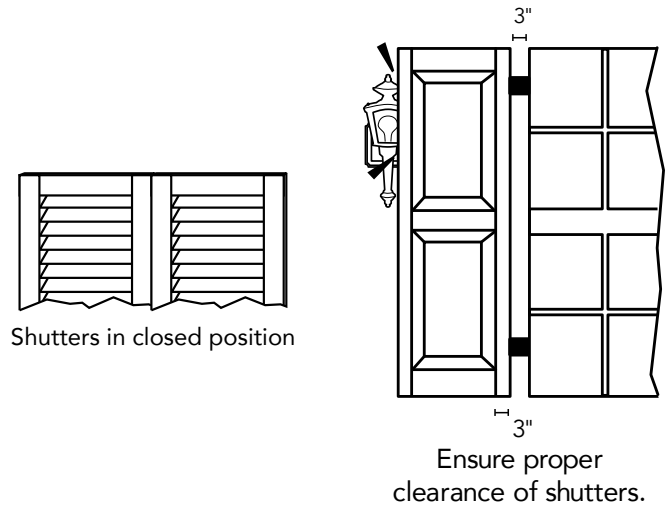

ARCHITECTURAL COLLECTION

Nominal Thickness: 1-1/4" stiles and side rails on Louvered Colonials, Combination, or Bahamas. 1" on Raised Panel styles.

Installation: To be installed in either a fixed or operable application in accordance with manufacturer's recommendations, with **no** nailing or screwing through face of shutter.

Material: Pultruded fiberglass and/or high density structural PVC and/or proprietary composite material. All slats and louvered side rails to be fiberglass.

Finish: Industrial grade two-part urethane, oven cured finish. 31 standard colors (custom colors available).

Hardware:

Colonial style shutters

- Black powder coated stainless steel, all other brads and fasteners also to be stainless steel.

Bahama

- Aluminum mill or anodized aluminum black finish arms. Hinges are aluminum with factory-applied two-part acrylic urethane finish.

Performance: All fiberglass louvers and side rails to be thermally stable from -100°F to +200°F.

Warranties: Lifetime against defects in materials and factory paint finish. Limited to original purchaser.

CLASSIC COLLECTION

Nominal Thickness: See page 37 & 38.

Installation: To be installed in a fixed application in accordance with manufacturer's recommendations, with **no** nailing or screwing through face of shutter.

Material: Solid core composite materials.

Finish: Industrial grade two-part urethane, oven cured finish. 31 standard colors (custom colors available).

Hardware:

Colonial style shutters

- Clear polycarbonate fixed mounting brackets.

Warranties: 10 Year against defects in materials and factory paint finish. Limited to original purchaser.



CAD Drawings available
online at: caddetails.com

ARCHITECTURAL COLLECTION – RAISED PANEL

Rails: Structural PVC with smooth outer skin

Panels: Proprietary exterior grade composite wood materials

Louvers: N/A

Stiles: Pultruded Structural Fiberglass

Primer: Entire product primed

Paint Finish: Two-part Urethane

Thickness: 1"

Width: 12"-30" (in 1/8" increments)

Height: 24"-108" (in 1/8" increments)

Vertical Stile: 2-1/2"

Top Rail: 3"

Middle Rail: 3"

Bottom Rail: 3"

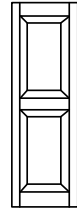

Standard

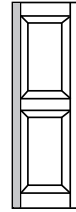

Butt Hinge

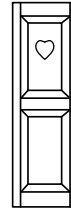

Cut-out

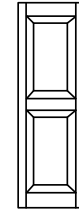

Rabbeted Edge
with Beading

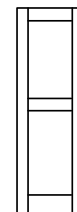

Flat Panel

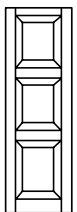

Extra Panel

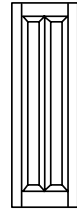

Single Panel w/
Vertical Cut Profile

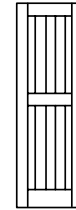

V-groove

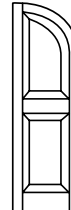

Arch or
Radius Top

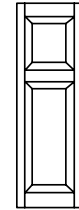

Custom Rail
Location



Single Panel

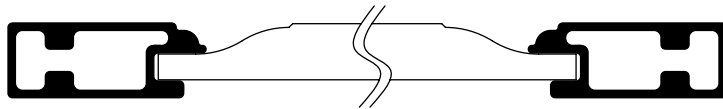

ARCHITECTURAL COLLECTION – LOUVERED COLONIAL

Rails: Structural PVC with smooth outer skin

Panels: N/A

Louvers: Pultruded Structural Fiberglass

Stiles: Pultruded Structural Fiberglass

Paint Finish: Two-part Urethane

Thickness: 1-1/4"

Width: 9" - 30" (in 1/8" increments)

Rail widths, if specified, may vary slightly due to louver/slat positioning

Height: 13-1/2"-108" (in 1/8" increments)

Vertical Stile: 2-1/4"

Top Rail: Standard 4"

Middle Rail: Standard 3-3/8"

Bottom Rail: Standard 4" (may vary)

Louver Angle: 25°

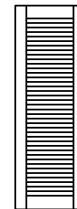

Standard

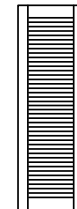

Rabbeted Edge

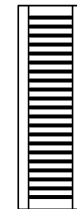

Bahama
Louver Spacing

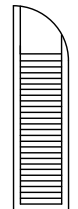

Solid Archtop

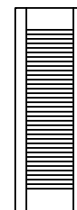

Custom Top or
Bottom Rail



Horns

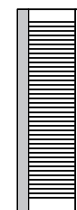

Butt Hinge

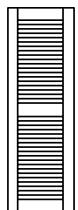

Additional Rail

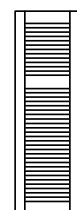

Custom Rail
Location



Vertical Mullion



Faux Tilt Rod

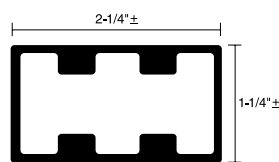
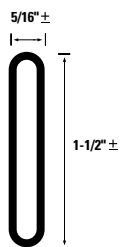

Wall Thickness 9/32" ±

Wall Thickness 9/32" ±

ARCHITECTURAL COLLECTION – COMBINATION

Rails: Structural PVC with smooth outer skin

Panels: Structural PVC with smooth outer skin

Louvers: Pultruded Structural Fiberglass

Stiles: Pultruded Structural Fiberglass

Paint Finish: Two-part Urethane

Thickness: 1-1/4"

Width: 12"-30" (in 1/8" increments)

Rail widths, if specified, may vary slightly due to louver/slat positioning

Height: 24"-108" (in 1/8" increments)

Vertical Stile: 2-1/4"

Top Rail: 4"

Middle Rail: 4"

Bottom Rail: 4"

Additional Rail: 3-3/8" or may vary 1-1/4" increments

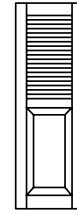

Standard

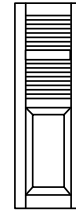

Additional
Rails

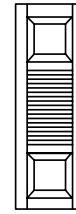

Extra
Panels

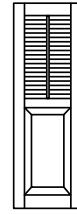

Vertical Mullion

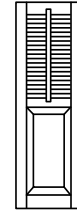

Faux Tilt
Rod

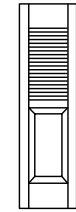

Custom Top
or Bottom Rail



Solid Panel
Arch Top

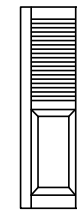

Rabbeted
Edge

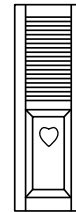

Cut-out

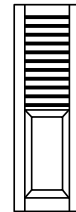

Bahama Louver
Spacing

ARCHITECTURAL COLLECTION – BAHAMA

Rails: Pultruded Structural Fiberglass

Slats: Pultruded Structural Fiberglass

Stiles: Pultruded Structural Fiberglass

Paint Finish: Two-part Urethane

Thickness: 1-1/4"

Width: 12"-119" (in 1/8" increments)

Height: 18-1/2"-119" (in 1-1/2" increments)

Vertical Stile: 2-1/4"

Top Rail: 2-1/4"

Middle Rail: 2.75"

Bottom Rail: 2-1/4"

Louver Angle: 36°

Prop Arm Angle: 30°

Widths from 30" – 59.875" require 1 vertical mullion which is automatically added.

Widths from 60" – 89.875" require 2 vertical mullions which are automatically added.

Widths from 90" – 119" require 3 vertical mullions which are automatically added.

Additional vertical mullions, rails and colonial louver spacing available upon request.



Less than 30"
With Mid-Rail



Less than 30"

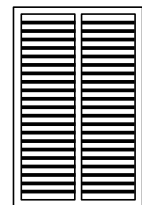

30" to less than 60"

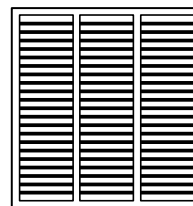

60" to less than 90"

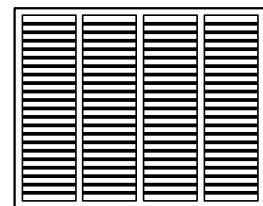

90" to less than 120"

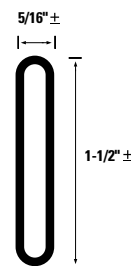

Wall Thickness 9/32" ±

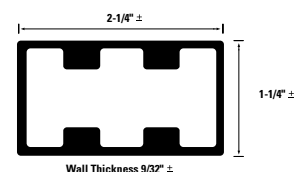

Wall Thickness 9/32" ±

CLASSIC COLLECTION – RAISED PANEL

Rails: Proprietary Exterior Grade Composite Wood
Panels: Proprietary Exterior Grade Composite Wood
Stiles: Proprietary Exterior Grade Composite Wood
Primer: Marine Grade
Paint Finish: Two-part Urethane
Width: 12" – 24" (in 1/8" increments)
Height: 13-1/2" – 96" (in 1/8" increments)

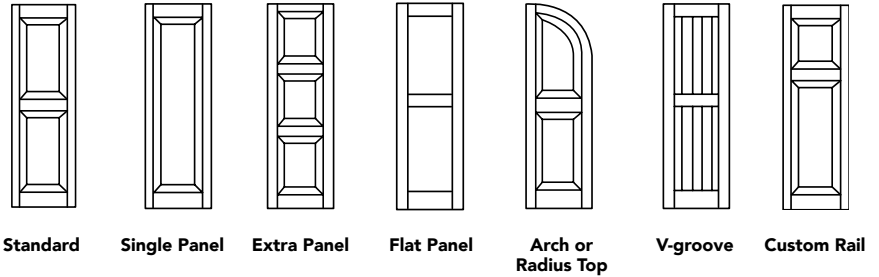

RAISED PANEL

Thickness: 1"
Vertical Stile Width (A): 2-1/2"
Top Rail Height (B): 2-1/2"
Middle Rail Height (C): 2-1/2"
Bottom Rail Height (D): 4-1/8"

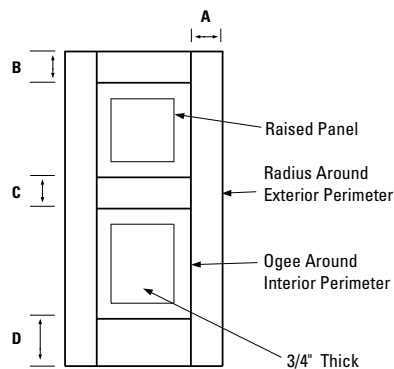

FLAT PANEL

Thickness: 1"
Vertical Stile Width (A): 2-1/2"
Top Rail Height (B): 2-1/2"
Middle Rail Height (C): 2-1/2"
Bottom Rail Height (D): 4-1/8"

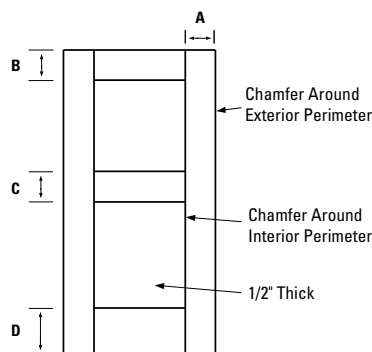

V-GROOVE

Thickness: 1"
Vertical Stile Width (A): 2-1/2"
Top Rail Height (B): 2-1/2"
Middle Rail Height (C): 2-1/2"
Bottom Rail Height (D): 4-1/8"

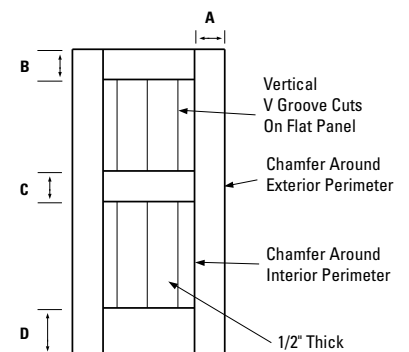

CLASSIC COLLECTION – FAUX LOUVER

Rails: Proprietary Exterior Grade Composite Wood
Panels: Proprietary Exterior Grade Composite Wood
Stiles: Proprietary Exterior Grade Composite Wood
Primer: Marine Grade
Paint Finish: Two-part Urethane
Width: 9" – 24" (in 1/8" increments)
Height: 13-1/2" – 96" (in 1/8" increments)

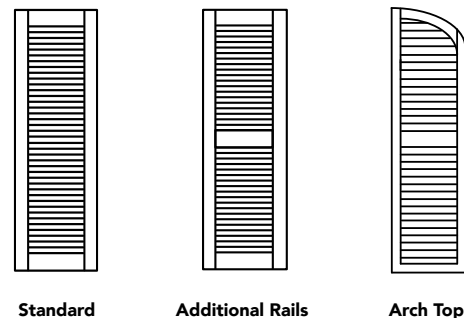

LOUVER

Thickness: 1-1/4"
Vertical Stile Width (A): 2-1/2"
Top Rail Height (B): 2-1/2"
Middle Rail Height (C): 2-1/2"
Bottom Rail Height (D): 2-3/4" – 4"
Louver Angle: 22°

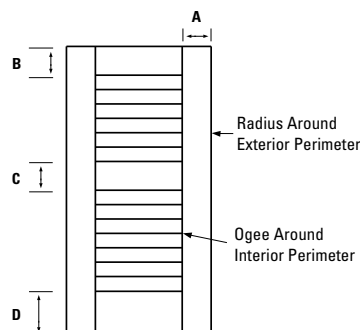

CLASSIC COLLECTION – BOARD AND BATTEN

- Rails:** Proprietary Exterior Grade Composite Wood
Panels: Proprietary Exterior Grade Composite Wood
Stiles: Proprietary Exterior Grade Composite Wood
Primer: Marine Grade
Paint Finish: Two-part Urethane
Thickness: 1", Batten is 1/2"
Width: 9"–24" (in 1/8" increments)
Height: 13-1/2"–84" (in 1/8" increments)
Batten Height: 4"
Batten Width: 1-1/2" Less than shutter width
Board Width: Grooves are cut approximately every 4"

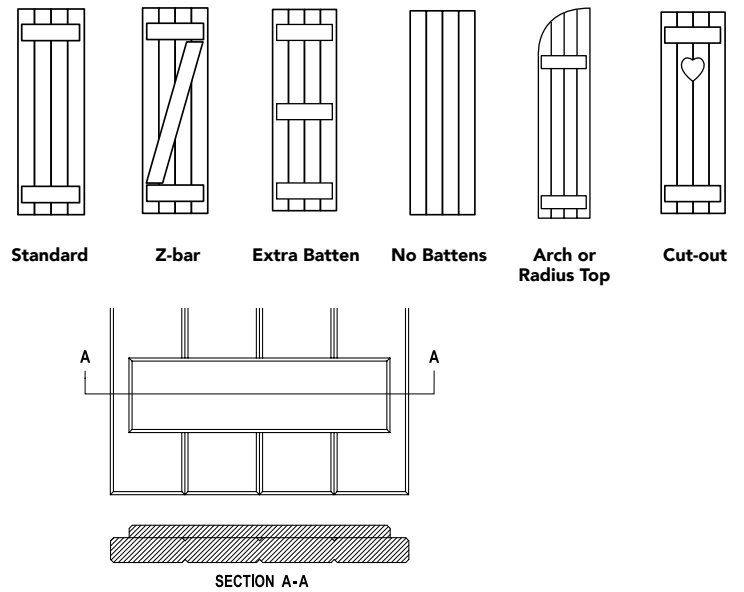

PROSERIES

Atlantic's ProSeries shutters are hand-assembled from exterior-grade composite wood components that will not rot, crack or split. ProSeries shutters come ready to be painted with any high-quality exterior paint of your choice. Each shutter is machine sanded and finished with a single coat of marine-grade primer reducing your time in applying a finish coat of paint.

ProSeries shutters are available in four different styles.

- Louver, Raised Panel, Flat Panel, Board and Batten.
- Quarter Round Arch Tops are available on all styles.

ProSeries shutters are available in the following sizes.

- Widths 12" to 24" in 1/2" increments.
- Heights 30" to 84" in 1" increments.

ProSeries shutters are primed only and should receive a finish coat of paint.

- Any good quality exterior grade finish paint should be used.
- Each shutter should be scuffed with a fine grit sandpaper prior to application of the finish paint coat.

Hardware for ProSeries Shutters is provided separately.

ProSeries shutters are backed by a 3 year structural warranty.

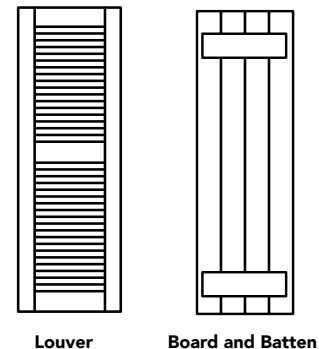
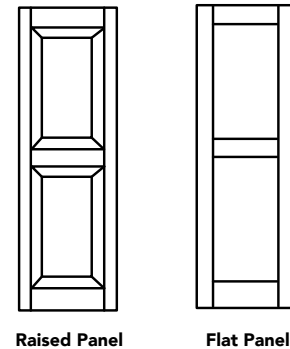

TRADITIONAL HARDWARE



Pintel on Plate

- Sold in pairs
- Pintel plate size - 1-1/2" x 3-1/2" x 1/8"
Pin diameter - 3/8"
- Stainless steel with a matte black powder coat finish
- Offsets: 1/2", 1-1/2", 2-1/4", 3-1/2"



Jamb Pintel Offset - 1/2", 1", 2"

- Sold in pairs
- Stainless steel with a matte black powder coat finish



4" Lag Pintel

- Sold in pairs
- Stainless steel with a matte black powder coat finish
- Pin diameter: 3/8"



Pintel Shim

- Sold as each
- Shim is 1/4" thick and stackable
- Black polyamide plastic



10" Strap Hinge

- Sold in pairs
- Stainless steel with a matte black powder coat finish
- Offsets: 0", 1/2", 1-1/2", 2-1/4"



10" Back Plate

- Sold in pairs
- Stainless steel with a matte black powder coat finish



12" Strap Hinge

- Sold in pairs
- Stainless steel with a matte black powder coat finish
- Offsets: 1/2", 1-1/2", 2-1/4"



12" Back Plate

- Sold in pairs
- Stainless steel with a matte black powder coat finish



6" L-Hinge

- Sold in same size pairs
- Stainless Steel with a matte black powder coat finish
- Offsets: 0", 1/2", 1-1/2", 2-1/4"



6" L-Hinge Back Plate

- Sold in pairs
- Stainless Steel with a matte black powder coat finish



Flat Hinge

- Sold in pairs
- Stainless Steel with a matte black powder coat finish
- Offsets: 0", 1/2", 1-1/2", 2-1/4"



Flat Hinge Back Plate

- Sold in pairs
- Stainless Steel with a matte black powder coat finish

TRADITIONAL HARDWARE



Acorn Holdback

- Sold as each
- Chromed Bronze Bullet
- Solid steel hanger bolt and spring clip



Dog Post Holdback

- Sold as each
- Stainless steel with a matte black powder coat finish



"S" Holdback

- Sold in pairs with 4" lag bolt, washer and cotter pin
- Stainless steel with a matte black powder coat finish



Rat-Tail Holdback

- Sold in pairs with 4" lag bolt, washer and cotter pin
- Stainless steel with a matte black powder coat finish



6" Lag Bolt

- Sold in pairs
- Stainless Steel with a matte black powder coat finish
- For use with "S" and Rat-Tail Holdbacks



12" Slide Bolt

- Sold as each
- Stainless Steel with a matte black powder coat finish



12" Locking Slide Bolt

- Sold as each
- Stainless Steel with a matte black powder coat finish



H-Hinge

- Sold in pairs
- Stainless Steel with a matte black powder coat finish



9" Adjustable Hinge with 3" Cleat

- Sold in pairs

EXAMPLES OF COMMON INSTALLATION OPTIONS - TRADITIONAL HARDWARE

Projected

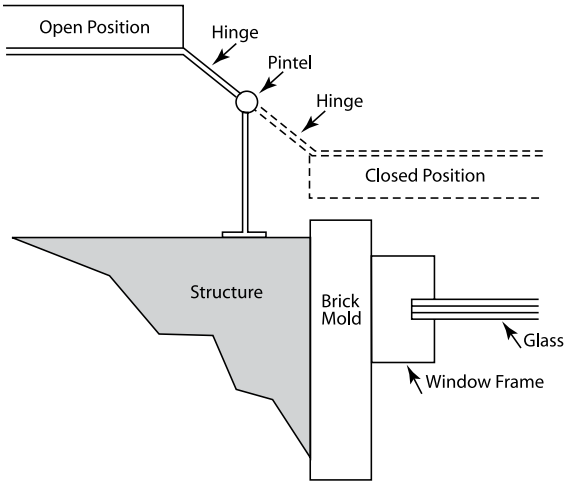

Recessed

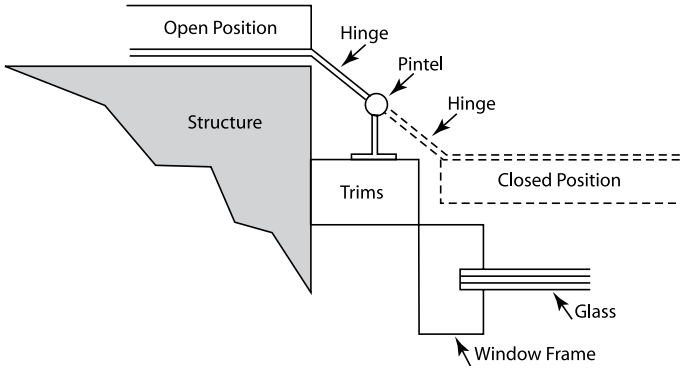

Flush

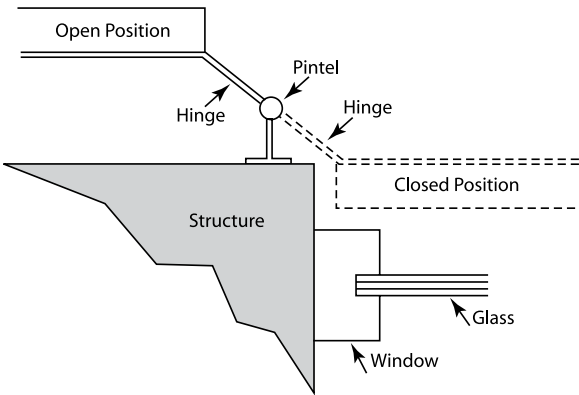

HINGE REQUIREMENTS

SHUTTER HEIGHT	12" to 48"	49" to 96"	97" to 108"
HINGE REQUIREMENT	2	3	4

FIXED MOUNTING HARDWARE

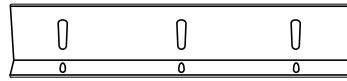

Fixed Mounting Bracket

- Sold in 4-piece set
- Clear polycarbonate
- Sizes 9", 14", 18"
- 4" Side bracket included for shutters over 48" tall

BAHAMA HARDWARE

NOTE: Female hinge clearance is not factored into overall shutter height.

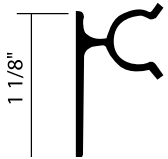

Male Hinge

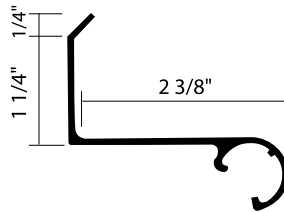

2 - 3/8" Female Hinge

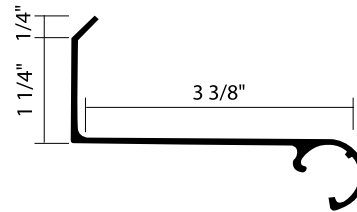

3 - 3/8" Female Hinge

TILT ARM COMPONENT PARTS

Aluminum tilt arms with nylon end caps



Stainless steel clevis pin



Nylon hinges/eye-end sets

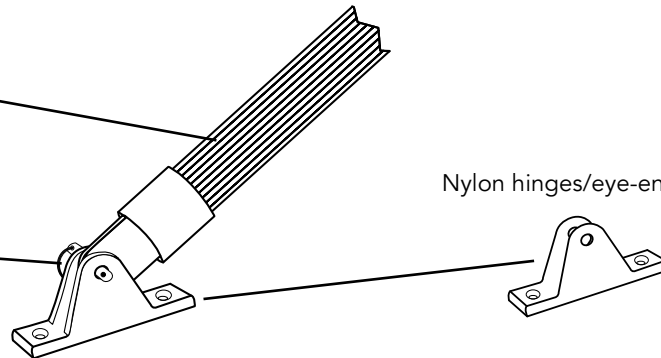

Examples of Common Installation Options - Bahama Hardware

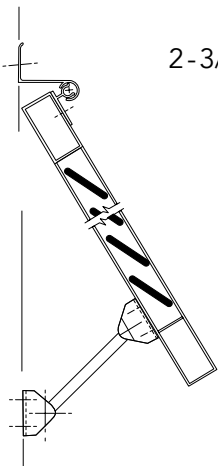

2-3/8" Female Hinge
Flush Mount

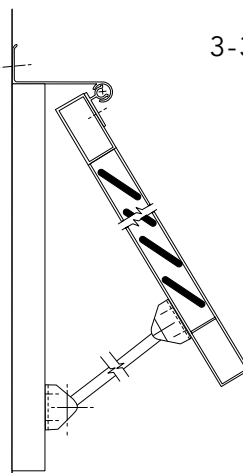

3-3/8" Female Hinge
Deep Set

IMPACT RESISTANT STORM SHUTTER HARDWARE & STORM BAR SYSTEMS

Inside Locking "U" Shaped Storm Bar System

The Inside Locking "U" Shaped Storm Bar System meets the Large Missile Impact Test requirement as specified in the IRC and IBC 2006.

- Available for Architectural Collection Louver and Raised Panel shutters. Does not apply to arch and radius top shutters, cutouts, combination, or bi-folds.
- Shutters can be ordered in 1/8" increments to a maximum size of 30" width and 96" length per shutter leaf.
- Each shutter leaf has a clear (1/8" thick) polycarbonate panel fastened to the back.

If shutter is over 46 inches, 2 Inside Locking "U" Shaped Storm Bars are required per shutter pair.

- Storm bar length 6", height 2", thickness 1/8", projection 1"
- Storm bars require installation by the shutter installer.
- Bolts and wing nuts are provided.

If Shutter is under 46 inches, it only requires 1 Inside locking "U" Shaped Storm Bar.

Horizontal Storm Bar System

Can be ordered in 1/8" increments to a maximum size of 60" w x 96" h window opening (shutter width of 30").

If shutter is over 46 inches, 2 Horizontal Storm Bars required per shutter pair.

- Storm bar length needs to match the total width of the shutter pair.
- Storm bars require installation by shutter installer.
- Bolts and wing nuts are provided.

If Shutter is under 46 inches, it only requires 1 Horizontal Storm Bar.

Bahama Storm System

The Bahama Storm System meets the State of Florida Building Code 2010.

- Architectural Collection Bahama style shutter.
- Shutters can be ordered in 1/8" width and 1-1/2" height increments to a maximum of 60" w x 103" h.
- Each shutter has a clear (1/8" thick) polycarbonate panel fastened to the back.

A camelback locking system is installed along the sides of the shutter, provided at no charge.

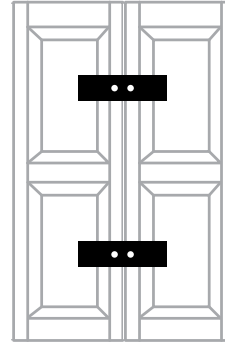

"U" Shaped Storm Bar

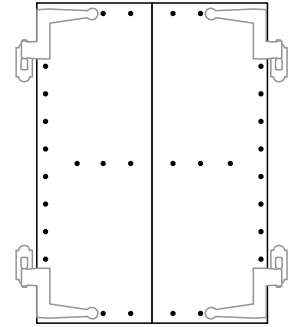

Polycarbonate Panel

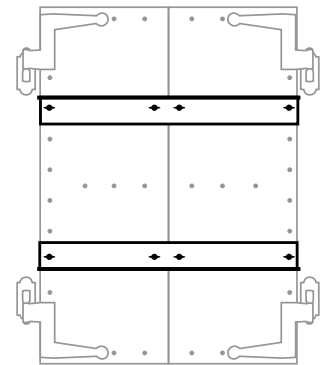

Horizontal Storm Bar

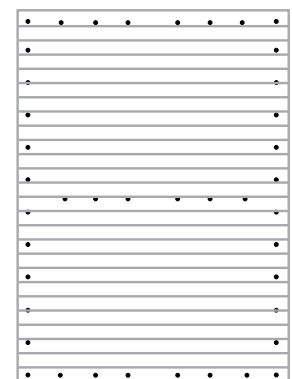

Bahama

Atlantic

Premium Shutters®



CAD Drawings available
online at: caddetails.com

