

General Guidelines for Installing Traditional Shutters

To deflect rain away from the structure, Louvered shutters should be installed so the louvers face **AWAY** from the structure when shutters are closed.
(see diagram at right)

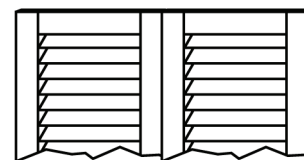

Shutters in closed position

1. Pick shutters to fit window and put next to each window on top of saw horses to make sure shutters are paired properly. Lay two shutters face down next to each and prepare to install hinges.



2. Install hinges after determining offset. Hinges are to be set at top and bottom even with outside. Drill holes with 1/8th pilot bit. Be careful not to drill all the way through shutter.



3. Position and install upper holdback clips 1" from top and center edge of stile. Shutters over 58" require sets of acorns; install similarly at top.



4. Install slide bolt. Turn shutters over and line-up slide bolt edge with shutter edge (see diagram at right). Pre-drill 1/8 slot hole (careful not to drill all the way through). Install slide bolt with screws. Shutters are now ready for installation.

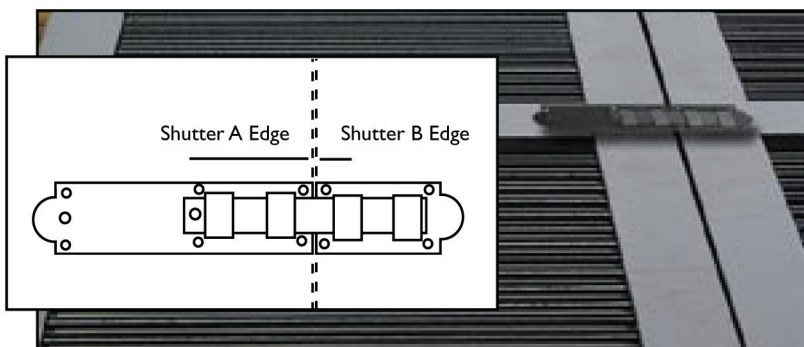

5. Position shutter in opening allowing equal amounts of space between shutter and wall (A, B), and between shutters (C) to allow for smooth operation (see diagram at right). When attaching the pintel to the structure you may have to drill into mortar and brick, use appropriate molly's in mortar and brick.

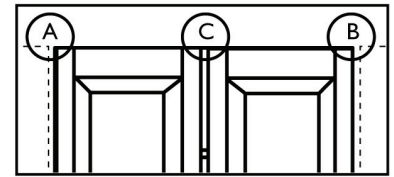
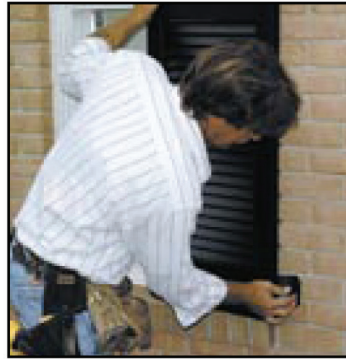

6. Install acorn clip. Swing shutter open and mark center of holdback clip. Install acorn clip into brick.

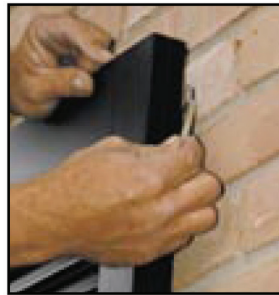

7. Install "S" Holdback.* The shutter is now held open by acorn anchor. Position shutter dog in correct location and mark for screws. Fasten to wall—1 3/4" down from shutter and 1 3/4" from outside edge.

**The acorn clip is better suited for holding the shutters in place, and as such, the "S" Holdback is recommended more for a decorative use as opposed to a functional one.*

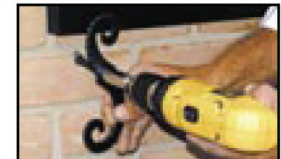

Shutter Terminology

Beaded	A beaded detail that is molded into the inside edge of the face of each stile.
Board and Batten	Traditionally used on barns but ideal for more rustic homes. Authentic tongue and groove look with the front and back of the shutter featuring the same beveled look as if the shutter were made of individual boards.
Flat Panel	A solid shutter where the center portion of the shutter is recessed from the stiles.
Fixed Louvered	The louvers are tilted in towards the wall when the shutter is in the open position.
Leaf	A single shutter or 1/2 pair.
Mullions	The vertical element between the stiles that acts as a divider. Found in Bahama shutters.
Rabbeting	Also called "shiplap", used on many functional shutters. When closed, the shutter leaves fit into one another.
Radius or Arch Top	A shutter which has a curved top.
Rails	The horizontal crosspieces of a shutter (i.e. top rail, bottom rail, center rail).
Raised Panel	A solid shutter where the center portion of the panel protrudes outward from the surrounding routed bevel.
Shutter Capping	A metal (usually copper) capping that was placed over the top edge of the shutter to prevent water intrusion and the resulting wood rot. This capping is not necessary with Atlantic shutters as, due to materials used, they are impervious to both water intrusion and rot.
Stiles	The upright vertical sections of a shutter, which may be beaded or non-beaded.
Tilt Rod	Working louvered shutters had a rod, or tilt-rod, to move the louvers into the open or closed position. These are now non-functional, purely decorative for those who truly desire the more authentic look.

Fixed Mount Applications The following components are included for Fixed Mount Applications



(4) Polycarbonate mounting brackets (slotted)



(8) #10 x 3/4" Stainless Steel Mounting Screws



(1) 0.5 oz. Tube All-Weather Silicone Caulk

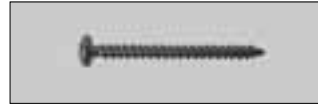

(8) #10 x 2" Stainless Steel Mounting Screws

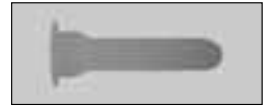

(8) Alligator Wall Anchors

1. Locate lower bracket.

Locate and position the mounting bracket next to the lower side of the window opening. The bracket is approximately 1" narrower than the shutter panel, which will leave 1/2" between window opening and the end of the mounting bracket. Using a level to verify that the mounting bracket is located correctly, mark the position of the two slots on the wall. The slots in the mounting bracket will allow for some minor adjustment in the vertical position.



2. Drill 1/4" hole and install anchor into wall.

With the slots properly marked on the wall, drill a 1/4" diameter hole 2" in depth at the desired location along the marked slots. In each of the 1/4" holes, place one of the alligator wall anchors. These anchors are suitable for mounting into concrete, aerated concrete, brick, masonry, stone, cinderblock, stucco and wood. Gently tap the head of the anchor until it is flush with the wall.



3. Secure bracket into wall at desired height with #10 x 2" screw.

Place the bracket up against the wall and locate the anchors through the mounting slots. Drive the 2" screw through the slot and into the alligator wall anchor. The anchor will expand in the wall and is not capable of coming out. However, the anchor may be reused if adjustment of the screw depth is necessary during the initial installation. Repeat this step to drive a second screw through the second slot. Make sure the bracket and mounting screws are secure onto the wall.



4. Locate top bracket and repeat steps 2 & 3 to mount.

Place the shutter on the lower bracket and stabilize so it cannot tip off. Take the second mounting bracket and locate the correct position at the top of the shutter panel by scribing a line to locate the height. Remove the shutter panel carefully. Place the bracket on the wall and mark the two slots in the desired location. Repeat steps #2 & #3 to complete the installation of the mounting bracket.



NOTE: If your shutter is longer than 48", you will need to install side brackets for additional support. See page 2.

5. Measure and Drill 9/64" pilot holes into shutter for #10 x 3/4" screw.

Place the shutter panel up against the wall in the desired position. The lower mounting bracket will support the weight, but be sure to stabilize the shutter panel so it does not tip off. Mark the location of the holes in the brackets to the top and bottom ends of the shutter. Remove the shutter from the wall and drill a 9/64" diameter hole 1" deep into the ends of the shutter in the 4 marked locations.



Make sure to drill the holes perpendicular to the shutter so as not to break through the surface of the shutter.



6. Place silicone on threads of #10 x 3/4" screws.

Take each of the 3/4" mounting screws and spread a bead of all-weather silicone caulk along the threads. This will provide a barrier between the mounting holes and the interior of the shutter panel.



7. Drive #10 x 3/4" screw into shutter.

Drive the 3/4" mounting screw, with silicone on the threads, into the pre-drilled pilot hole until the screw is snug. Make sure not to overtighten the mounting screw, which may cause the material to strip out. Repeat this for each of the mounting screws, two per mounting bracket. The shutter panel is now properly mounted. Repeat steps 1-7 for the second shutter.



You have successfully mounted a pair of shutters.

Fixed Mount Applications The following components are included for Fixed Mount Applications over 48" in length.



(2) Polycarbonate mounting brackets (slotted)



(4) #10 x 3/4" Stainless Steel Mounting Screws



(1) 0.5 oz. Tube All-Weather Silicone Caulk



(4) #10 x 2" Stainless Steel Mounting Screws



(4) Alligator Wall Anchors

Installation of side brackets for additional support. For shutters longer than 48".

1. Locate Center

Find the center of the shutter and place a mark.



2. Position bracket on wall

Align your 4 1/2" bracket to the center of the shutter and place your shutter between the upper and lower brackets on the wall. Be sure to stabilize the shutter so it does not tip off. Mark the outside edge of the bracket. With side bracket remaining on the wall, remove shutter and mark slots on bracket. Note: This is performed on both sides.



3. Drill 1/4" hole and install anchor into wall

With the slots properly marked on the wall drill a 1/4" diameter hole 2" in depth at the desired location along the marked slots. In each of the 1/4" holes, place one of the alligator wall anchors. Gently tap the head of the anchor until it is flush with the wall.



4. Secure bracket into wall at desired height with #10 x 2" screw

Place the bracket up against the wall and locate the anchors through the mounting slots. Drive the 2" screw through the slot and into the alligator wall anchor. The anchor will expand in the wall and is not capable of coming out. However, the anchor may be reused if adjustment of the screw depth is necessary during the initial installation. Make sure the bracket and mounting screw are secure onto the wall.



5. Measure and drill 9/64" pilot holes into shutter for #10 x 3/4" screw

Place the shutter panel up against the wall in the desired position. The lower mounting bracket will support the weight, but be sure to stabilize the shutter panel so it does not tip off. Mark the location of the holes in the side bracket. Remove the shutter from the wall and drill a 9/64" diameter hole 1" deep into the side of the shutter in the 3 marked locations.



6. Place silicone on threads of #10 x 3/4" screws

Take each of the 3/4" mounting screws and spread a bead of all-weather silicone caulk along the threads. This will provide a barrier between the mounting holes and the interior of the shutter panel.



7. Drive #10 x 3/4" screws into shutter

Drive the 3/4" mounting screw, with silicone on the threads, into the pre-drilled pilot hole until the screw is snug. Make sure not to overtighten the mounting screw, which may cause the material to strip out. The shutter panel is now properly mounted. Repeat steps 1-7 for the second shutter.



You have successfully side mounted a pair of shutters