

Atlantic

Premium Shutters®

SPECIFICATIONS



CAD Drawings available
online at: caddetails.com



GENERAL NOTES

To deflect rain away from the structure, louvered shutters should be installed so the louvers face AWAY from the structure when shutters are closed.

Shutter swing is 3" per shutter from the edge of the open shutter to the edge of the window opening when the shutter is closed; be sure to check for proper clearance (i.e. lamps, fixtures) when the shutter is in the open position.

Hinges are usually applied to the back of the shutter. They are only visible in their entirety when the shutter is in the closed position.

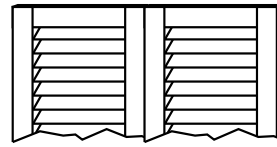

Shutters in closed position

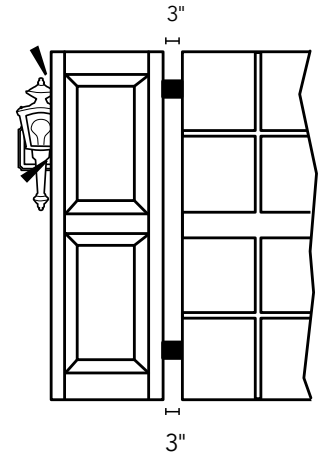

Ensure proper clearance of shutters.

ARCHITECTURAL COLLECTION

MANUFACTURED BY:

Atlantic Premium Shutters,
Latta, South Carolina (O/E)

Nominal Thickness: 1-1/4" stiles and side rails on Louvered Colonials, Combination, or Bahamas. 1" on Raised Panel styles.

Installation: To be installed in either a fixed or operable application in accordance with manufacturer's recommendations, with **no** nailing or screwing through face of shutter.

Material: Pultruded fiberglass and/or high density structural PVC and/or proprietary composite material. All slats and louvered side rails to be fiberglass.

Finish: Industrial grade two-part urethane, oven cured finish. 31 standard colors (custom colors available).

Hardware:

Colonial style shutters

- Black powder coated stainless steel, all other brads and fasteners also to be stainless steel.

Bahama

- Aluminum mill or anodized aluminum black finish arms. Hinges are aluminum with factory-applied two-part acrylic urethane finish.

Performance: All fiberglass louvers and side rails to be thermally stable from -100°F to +200°F.

Warranties: Lifetime against defects in materials and factory paint finish. Limited to original purchaser.

CLASSIC COLLECTION

MANUFACTURED BY:

Atlantic Premium Shutters,
Latta, South Carolina (O/E)

Nominal Thickness: See page 5 & 6.

Installation: To be installed in a fixed application in accordance with manufacturer's recommendations, with **no** nailing or screwing through face of shutter.

Material: Solid core composite materials.

Finish: Industrial grade two-part urethane, oven cured finish. 31 standard colors (custom colors available).

Hardware:

Colonial style shutters

- Clear polycarbonate fixed mounting brackets.

Warranties: 10 Year against defects in materials and factory paint finish. Limited to original purchaser.

ARCHITECTURAL COLLECTION – RAISED PANEL

Rails: Structural PVC with smooth outer skin
Panels: Proprietary exterior grade composite wood materials
Louvers: N/A
Stiles: Pultruded Structural Fiberglass
Primer: Entire product primed
Paint Finish: Two-part Urethane
Thickness: 1"
Width: 12"-30" (in 1/8" increments)
Height: 24"-108" (in 1/8" increments)
Vertical Stile: 2-1/2"
Top Rail: 3"
Middle Rail: 3"
Bottom Rail: 3"

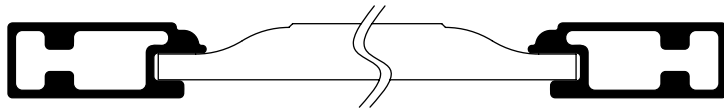
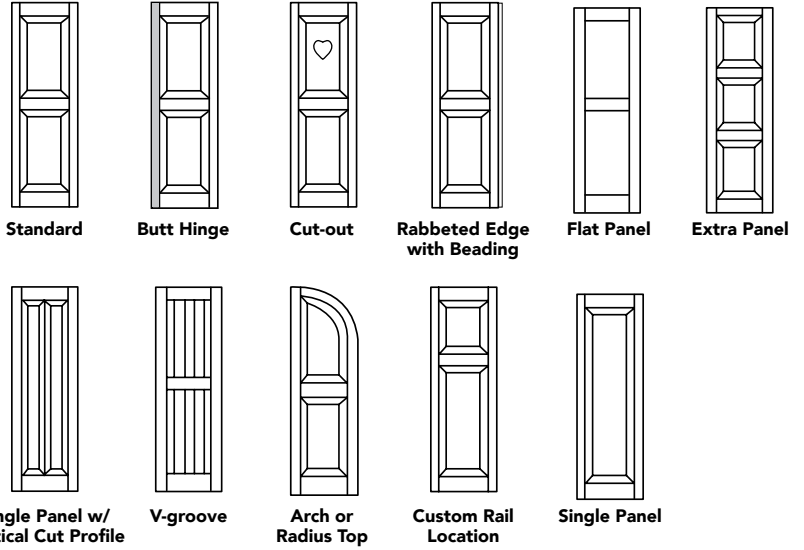

ARCHITECTURAL COLLECTION – LOUVERED COLONIAL

Rails: Structural PVC with smooth outer skin
Panels: N/A
Louvers: Pultruded Structural Fiberglass
Stiles: Pultruded Structural Fiberglass
Paint Finish: Two-part Urethane
Thickness: 1-1/4"
Width: 9" - 30" (in 1/8" increments)
 Rail widths, if specified, may vary slightly due to louver/slat positioning.
Height: 13-1/2"-108" (in 1/8" increments)
Vertical Stile: 2-1/4"
Top Rail: Standard 4"
Middle Rail: Standard 3-3/8"
Bottom Rail: Standard 4" (may vary)
Louver Angle: 25°

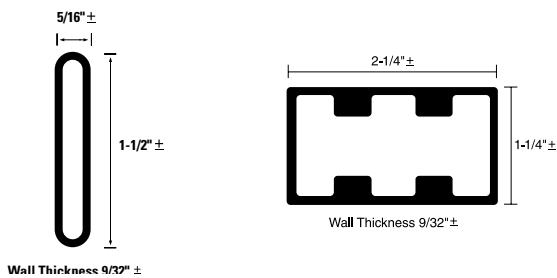
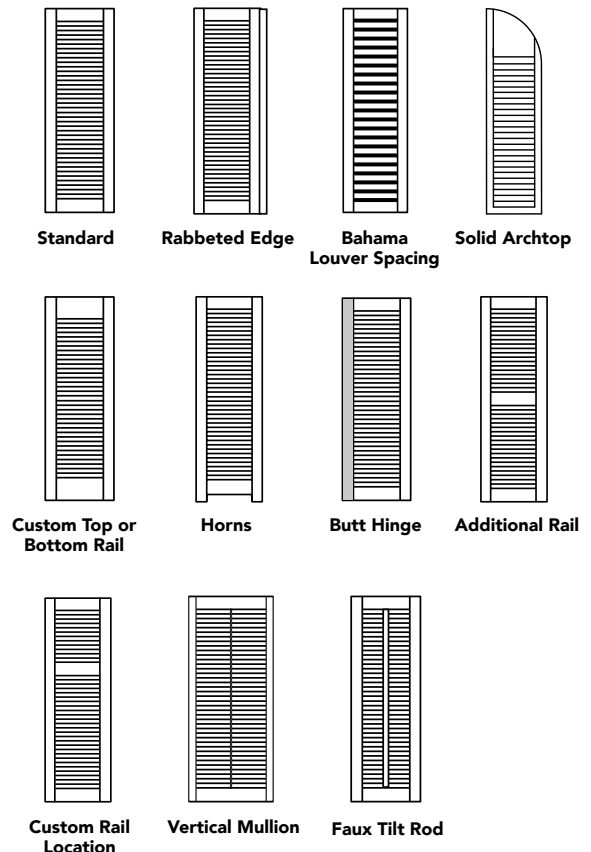

ARCHITECTURAL COLLECTION – COMBINATION

Rails: Structural PVC with smooth outer skin

Panels: Structural PVC with smooth outer skin

Louvers: Pultruded Structural Fiberglass

Stiles: Pultruded Structural Fiberglass

Paint Finish: Two-part Urethane

Thickness: 1-1/4"

Width: 12"-30" (in 1/8" increments)

Rail widths, if specified, may vary slightly due to louver/slat positioning

Height: 24"-108" (in 1/8" increments)

Vertical Stile: 2-1/4"

Top Rail: 4"

Middle Rail: 4"

Bottom Rail: 4"

Additional Rail: 3-3/8" or may vary 1-1/4" increments

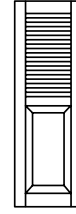

Standard

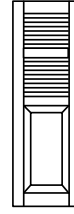

Additional
Rails

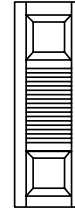

Extra
Panels

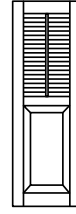

Vertical Mullion

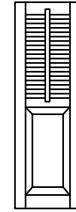

Faux Tilt
Rod

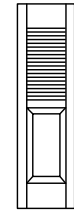

Custom Top
or Bottom Rail



Solid Panel
Arch Top

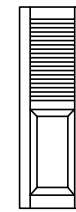

Rabbeted
Edge

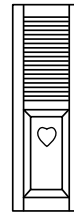

Cut-out

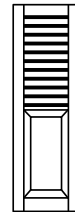

Bahama Louver
Spacing

ARCHITECTURAL COLLECTION – BAHAMA

Rails: Pultruded Structural Fiberglass

Slats: Pultruded Structural Fiberglass

Stiles: Pultruded Structural Fiberglass

Paint Finish: Two-part Urethane

Thickness: 1-1/4"

Width: 12"-119" (in 1/8" increments)

Height: 18-1/2"-119" (in 1-1/2" increments)

Vertical Stile: 2-1/4"

Top Rail: 2-1/4"

Middle Rail: 2.75"

Bottom Rail: 2-1/4"

Louver Angle: 36°

Prop Arm Angle: 30°



Less than 30"
With Mid-Rail



Less than 30"

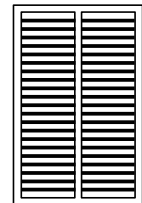

30" to less than 60"

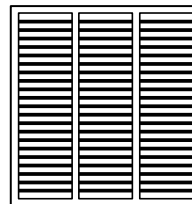

60" to less than 90"

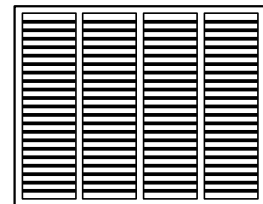

90" to less than 120"

Widths from 30" – 59.875" require 1 vertical mullion which is automatically added.

Widths from 60" – 89.875" require 2 vertical mullions which are automatically added.

Widths from 90" – 119" require 3 vertical mullions which are automatically added.

Additional vertical mullions, rails and colonial louver spacing available upon request.

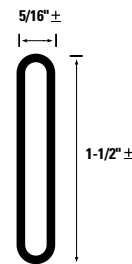

Wall Thickness 9/32" ±

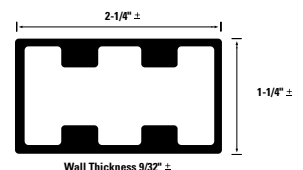

Wall Thickness 9/32" ±

CLASSIC COLLECTION – RAISED PANEL

Rails: Proprietary Exterior Grade Composite Wood
Panels: Proprietary Exterior Grade Composite Wood
Stiles: Proprietary Exterior Grade Composite Wood
Primer: Marine Grade
Paint Finish: Two-part Urethane
Width: 12" – 24" (in 1/8" increments)
Height: 13-1/2" – 96" (in 1/8" increments)

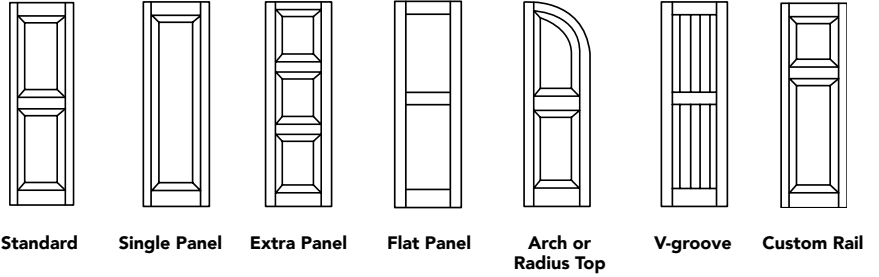

RAISED PANEL

Thickness: 1"
Vertical Stile Width (A): 2-1/2"
Top Rail Height (B): 2-1/2"
Middle Rail Height (C): 2-1/2"
Bottom Rail Height (D): 4-1/8"

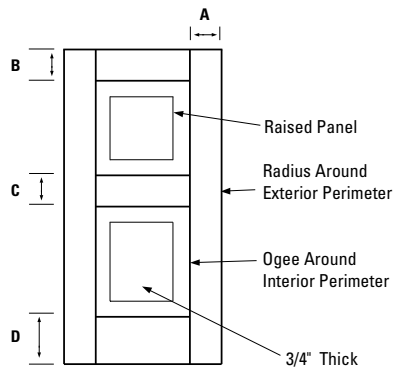

FLAT PANEL

Thickness: 1"
Vertical Stile Width (A): 2-1/2"
Top Rail Height (B): 2-1/2"
Middle Rail Height (C): 2-1/2"
Bottom Rail Height (D): 4-1/8"

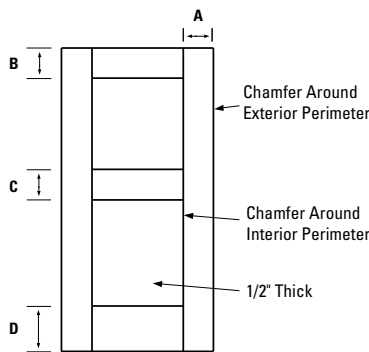

V-GROOVE

Thickness: 1"
Vertical Stile Width (A): 2-1/2"
Top Rail Height (B): 2-1/2"
Middle Rail Height (C): 2-1/2"
Bottom Rail Height (D): 4-1/8"

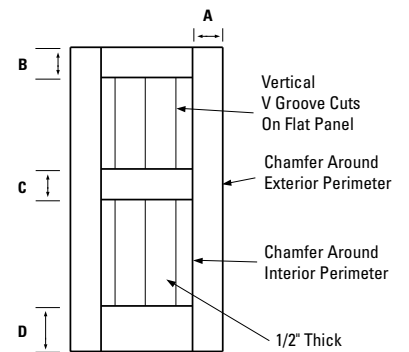

CLASSIC COLLECTION – FAUX LOUVER

Rails: Proprietary Exterior Grade Composite Wood
Panels: Proprietary Exterior Grade Composite Wood
Stiles: Proprietary Exterior Grade Composite Wood
Primer: Marine Grade
Paint Finish: Two-part Urethane
Width: 9" – 24" (in 1/8" increments)
Height: 13-1/2" – 96" (in 1/8" increments)

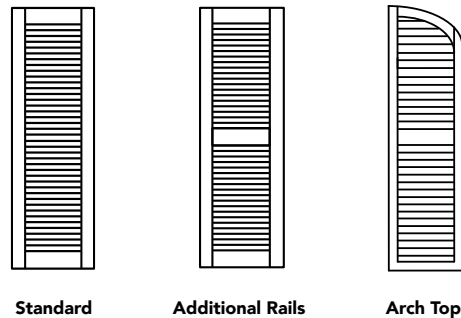

LOUVER

Thickness: 1-1/4"
Vertical Stile Width (A): 2-1/2"
Top Rail Height (B): 2-1/2"
Middle Rail Height (C): 2-1/2"
Bottom Rail Height (D): 2-3/4" – 4"
Louver Angle: 22°

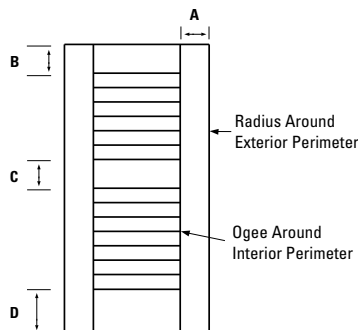

CLASSIC COLLECTION – BOARD AND BATTEN

- Rails:** Proprietary Exterior Grade Composite Wood
Panels: Proprietary Exterior Grade Composite Wood
Stiles: Proprietary Exterior Grade Composite Wood
Primer: Marine Grade
Paint Finish: Two-part Urethane
Thickness: 1", the Batten is 1/2"
Width: 9"–24" (in 1/8" increments)
Height: 13-1/2"–84" (in 1/8" increments)
Batten Height: 4"
Batten Width: 1-1/2" Less than shutter width
Board Width: Grooves are cut approximately every 4"

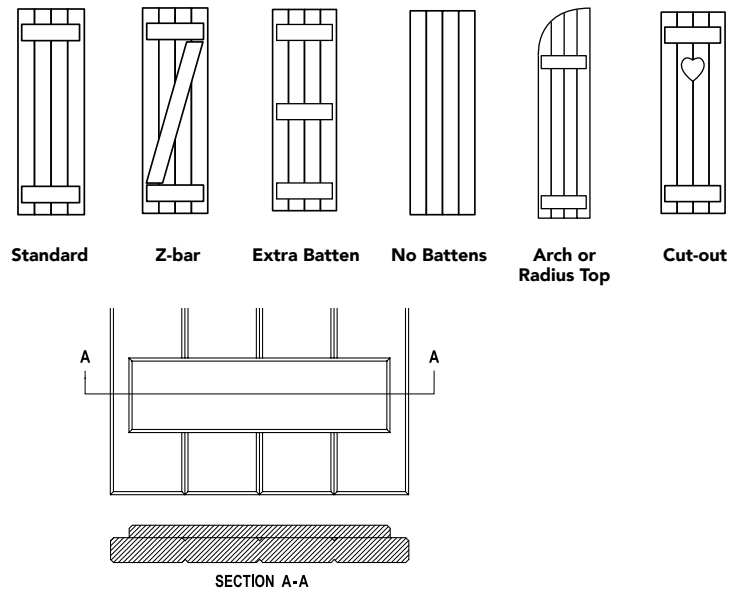

PROSERIES

Atlantic's ProSeries shutters are hand-assembled from exterior-grade composite wood components that will not rot, crack or split. ProSeries shutters come ready to be painted with any high-quality exterior paint of your choice. Each shutter is machine-sanded and finished with a single coat of marine-grade primer reducing your time in applying a finish coat of paint.

ProSeries shutters are available in four different styles.

- Louver, Raised Panel, Flat Panel, Board and Batten.
- Quarter Round Arch Tops are available on Raised Panel, Flat Panel, Louver, and Board and Batten Shutters.

ProSeries shutters are available in the following sizes.

- Widths 12" to 24" in 1/2" increments.
- Heights 30" to 84" in 1" increments.

ProSeries shutters are primed only and should receive a finish coat of paint.

- Any good quality exterior grade finish paint should be used.
- Each shutter should be scuffed with a fine grit sandpaper prior to application of the finish paint coat.

Hardware for ProSeries Shutters is provided separately.

ProSeries shutters are backed by a 3 year structural warranty.

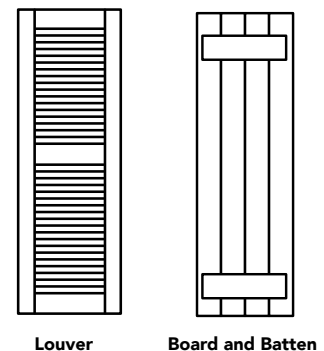
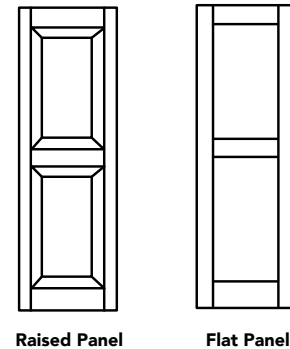

TRADITIONAL HARDWARE



Pintel on Plate

- Sold in pairs
- Pintel plate size - 1-1/2" x 3-1/2" x 1/8"
Pin diameter - 3/8"
- Stainless steel with a matte black powder coat finish
- Offsets: 1/2", 1-1/2", 2-1/4", 3-1/2"



Jamb Pintel Offset - 1/2", 1", 2"

- Sold in pairs
- Stainless steel with a matte black powder coat finish



4" Lag Pintel

- Sold in pairs
- Stainless steel with a matte black powder coat finish
- Pin diameter: 3/8"



Pintel Shim

- Sold as each
- Shim is 1/4" thick and stackable
- Black polyamide plastic



10" Strap Hinge

- Sold in pairs
- Stainless steel with a matte black powder coat finish
- Offsets: 0", 1/2", 1-1/2", 2-1/4"



10" Backplate

- Sold in pairs
- Stainless steel with a matte black powder coat finish



12" Strap Hinge

- Sold in pairs
- Stainless steel with a matte black powder coat finish
- Offsets: 1/2", 1-1/2", 2-1/4"



12" Back Plate

- Sold in pairs
- Stainless steel with a matte black powder coat finish



6" L-Hinge

- Sold in same size pairs
- Stainless Steel with a matte black powder coat finish
- Offsets: 0", 1/2", 1-1/2", 2-1/4"



6" L-Hinge Back Plate

- Sold in pairs
- Stainless Steel with a matte black powder coat finish



Flat Hinge

- Sold in pairs
- Stainless Steel with a matte black powder coat finish
- Offsets: 0", 1/2", 1-1/2", 2-1/4"



Flat Hinge Backplate

- Sold in pairs
- Stainless Steel with a matte black powder coat finish

TRADITIONAL HARDWARE



Acorn Holdback

- Sold as each
- Chromed Bronze Bullet
- Sold steel hanger bolt and spring clip



Dog Post Holdback

- Sold as each
- Stainless steel with a matte black powder coat finish



"S" Holdback

- Sold in pairs with 4" lag bolt, washer and cotter pin
- Stainless steel with a matte black powder coat finish



Rat-Tail Holdback

- Sold in pairs with 4" lag bolt, washer and cotter pin
- Stainless steel with a matte black powder coat finish



6" Lag Bolt

- Sold in pairs
- Stainless Steel with a matte black powder coat finish
- For use with "S" and Rat-Tail Holdbacks



12" Slide Bolt

- Sold as each
- Stainless Steel with a matte black powder coat finish



12" Locking Slide Bolt

- Sold as each
- Stainless Steel with a matte black powder coat finish



H-Hinge

- Sold in pairs
- Stainless Steel with a matte black powder coat finish



9" Adjustable Hinge with 3" Cleat

- Sold in pairs

EXAMPLES OF COMMON INSTALLATION OPTIONS - TRADITIONAL HARDWARE

Projected

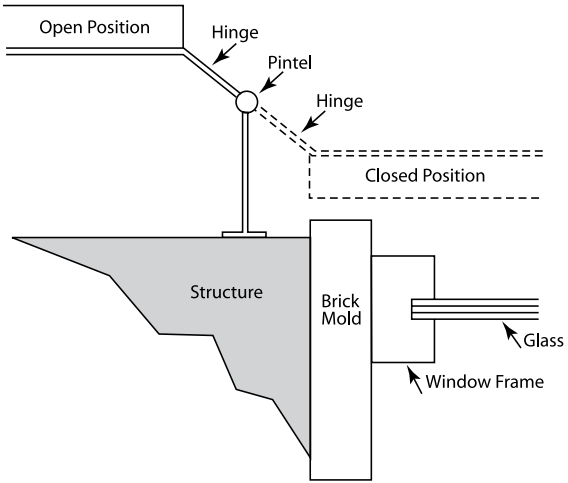

Recessed

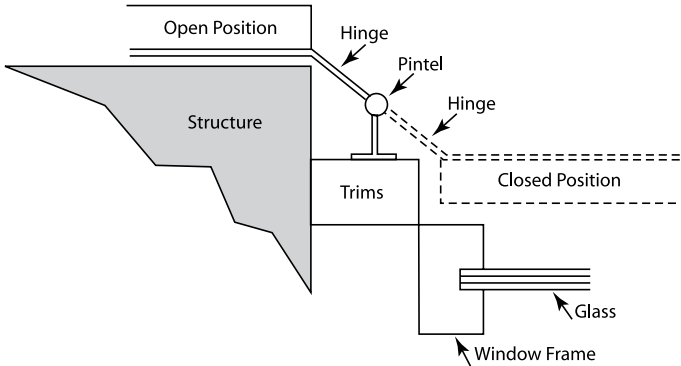

Flush

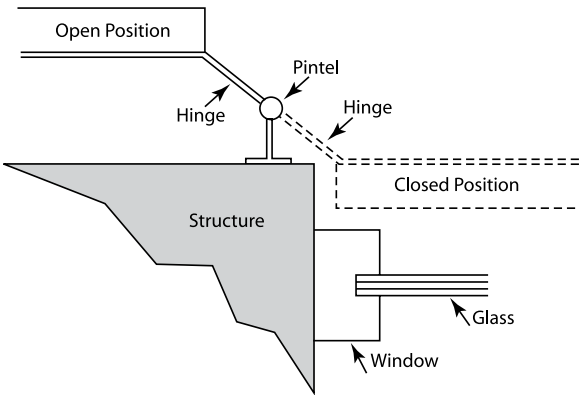

HINGE REQUIREMENTS

SHUTTER HEIGHT	12" to 48"	49" to 96"	97" to 108"
HINGE REQUIREMENT	2	3	4

FIXED MOUNTING HARDWARE

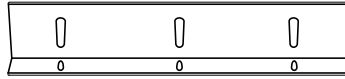

- Fixed Mounting Bracket**
- Sold in 4-piece set
 - Clear polycarbonate
 - Sizes 9", 14", 18"
 - 4" Side bracket included for shutters over 48" tall

BAHAMA HARDWARE

NOTE: Female hinge clearance is not factored into overall shutter height.

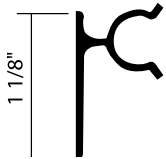

Male Hinge

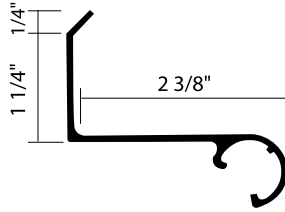

2 - 3/8" Female Hinge

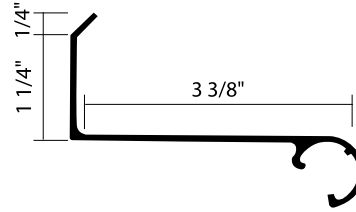

3 - 3/8" Female Hinge

TILT ARM COMPONENT PARTS

Aluminum tilt arms with nylon end caps



Stainless steel clevis pin



Nylon hinges/eye-end sets

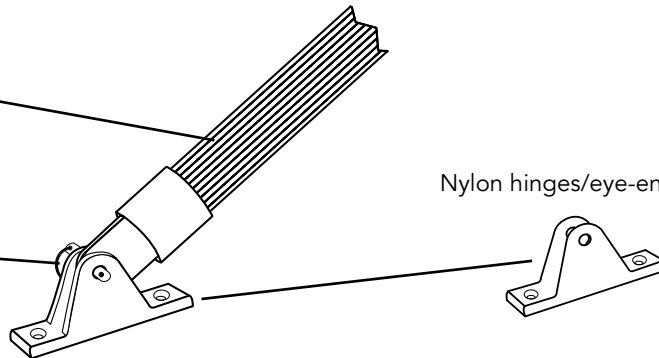

Examples of Common Installation Options - Bahama Hardware

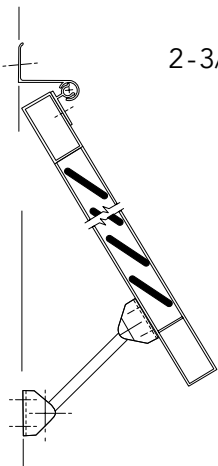

2-3/8" Female Hinge
Flush Mount

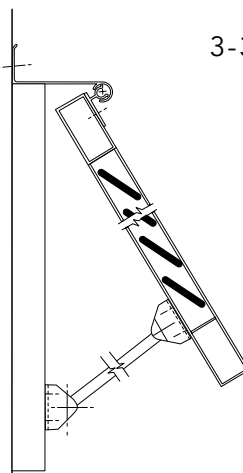

3-3/8" Female Hinge
Deep Set

**IMPACT RESISTANT STORM SHUTTER
HARDWARE & STORM BAR SYSTEMS**



Inside Locking "U" Shaped Storm Bar System

The Inside Locking "U" Shaped Storm Bar System meets the Large Missile Impact Test requirement as specified in the IRC and IBC 2006.

- Architectural Collection Louver and Raised Panel (Does not apply to arch and radius top shutters, cutouts, combination, or bi-folds.)
- Shutters can be ordered in 1/8" increments to a maximum size of 30" width and 96" length per shutter leaf.
- Each shutter leaf has a clear (1/8" thick) polycarbonate panel fastened to the back.

If shutter is over 46 inches, 2 Inside Locking "U" Shaped Storm Bars are required per shutter pair.

- Storm bar length 6", height 2", thickness 1/8", projection 1"
- Storm bars require installation by the shutter installer.
- Bolts and wing nuts are provided.

If Shutter is under 46 inches, it only requires 1 Inside locking "U" Shaped Storm Bar.

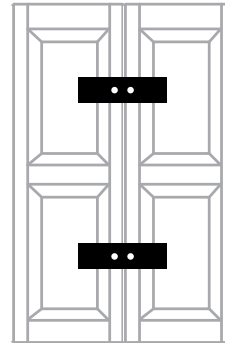

"U" Shaped Storm Bar

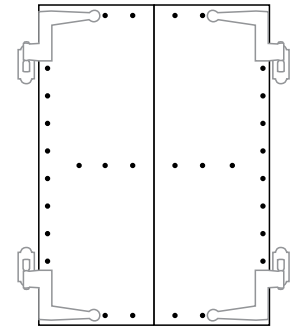

Polycarbonate Panel

Horizontal Storm Bar System

Can be ordered in 1/8" increments to a maximum size of 60" w x 96" h window opening (shutter width of 30").

If shutter is over 46 inches, 2 Horizontal Storm Bars required per shutter pair.

- Storm bar length needs to match the total width of the shutter pair.
- Storm bars require installation by shutter installer.
- Bolts and wing nuts are provided.

If Shutter is under 46 inches, it only requires 1 Horizontal Storm Bar.

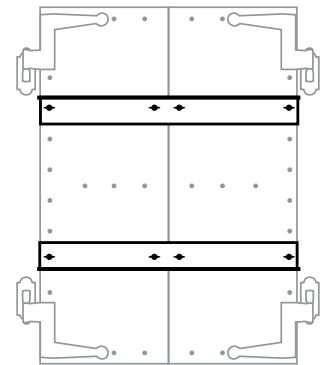

Horizontal Storm Bar

Bahama Storm System

The Bahama Storm System meets the State of Florida Building Code 2010.

- Architectural Collection Bahama style shutter.
- Shutters can be ordered in 1/8" width and 1-1/2" height increments to a maximum of 60" w x 103" h.
- Each shutter has a clear (1/8" thick) polycarbonate panel fastened to the back.

A camel back locking system is installed along the sides of the shutter, provided at no charge.

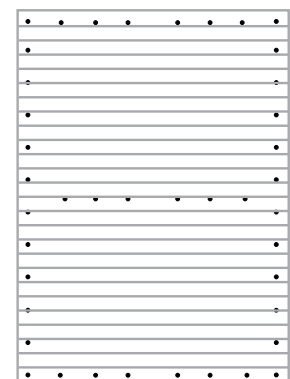

Bahama

Atlantic Premium Shutters®



CAD Drawings available
online at: **caddetails.com**